

# 1 Installation

## Installation Environment:

Indoor use only.  
Avoid backlight, direct sunlight, and indirect sunlight.  
For Better recognition, there should be light source in or near the installation environment.  
The minimum bearing weight of the wall or other places should be 3 times heavier than the device weight.

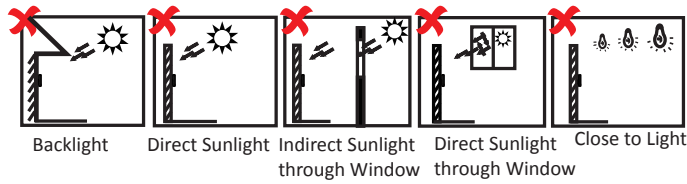

## Wall Mounting

1 Make sure the gang box is installed on the wall.

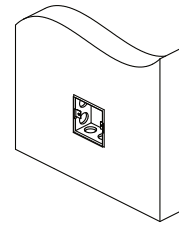

Gang box is not supplied.

3 Align the device with the mounting plate, and secure the device on the mounting plate with 1 supplied screw (SC-CM4X14-5T10-SUSS).

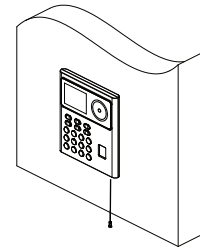

2 Secure the mounting plate on the gang box with two supplied screws (SC-KA4X22). Route the cable through the cable hole, wire the cables and insert the cables in the gang box.

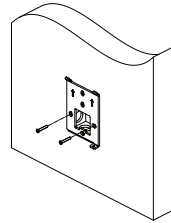

You can install the battery backplane (supplied) with 3 screws (SC-KA4X22) before installing the device. The dimension with the battery backplane is as below. (unit: mm [inch])

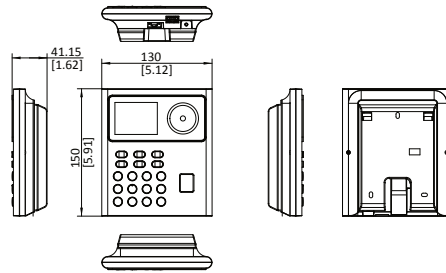

## Base Mounting

1 Route the cable through the cable hole of the bracket. Align the bracket with the device rear panel.

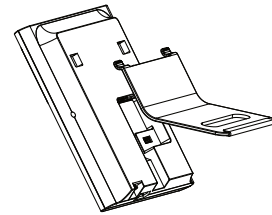

3 Slide to the end to complete the installation.

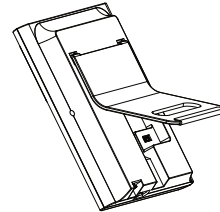

Bracket is optional.

2 Press the bracket with both hands. Make sure the rear panel of the device and the buckles of the bracket are aligned with each other. Slide and buckle the bracket along the arrow.

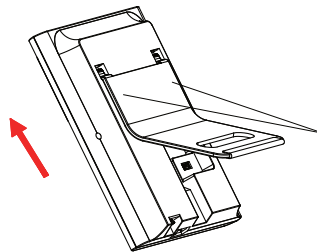

Press with Both Hands

You can install the battery backplane (supplied) with 3 screws (SC-KA4X22) before installing the device. The dimension with the battery backplane is as below. (unit: mm [inch])

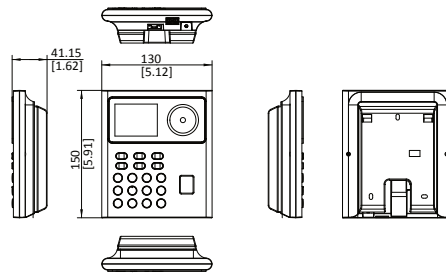

# 2 Appearance

The figures are for reference only.

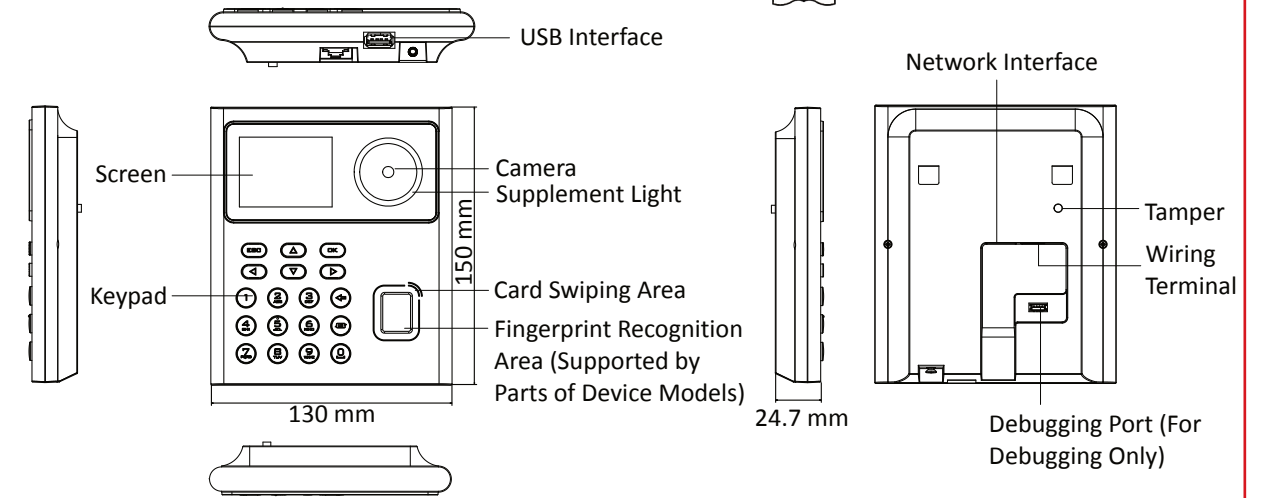

## Keypad

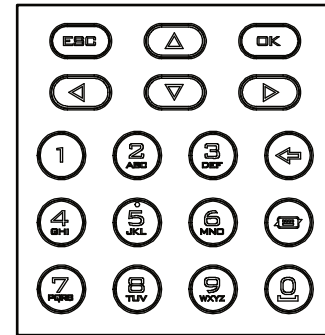

- Numeric Key** 0~9. Digits, letters, and characters can be entered in the textbox via the numeric keys. 0 is reused as space bar when not entering digits.
- Direction Key** Control four directions: front, back, left, and right.
- ESC** Exit key. Exit the current page or return to the previous page.
- OK** In the standby page, hold to enter the administrator login interface, and press to confirm. Used as confirmation and selection key after login.
- Delete Key** Delete key. Delete textbox contents.
- Input method shifting key** Input method shifting key.

# 3 Wiring

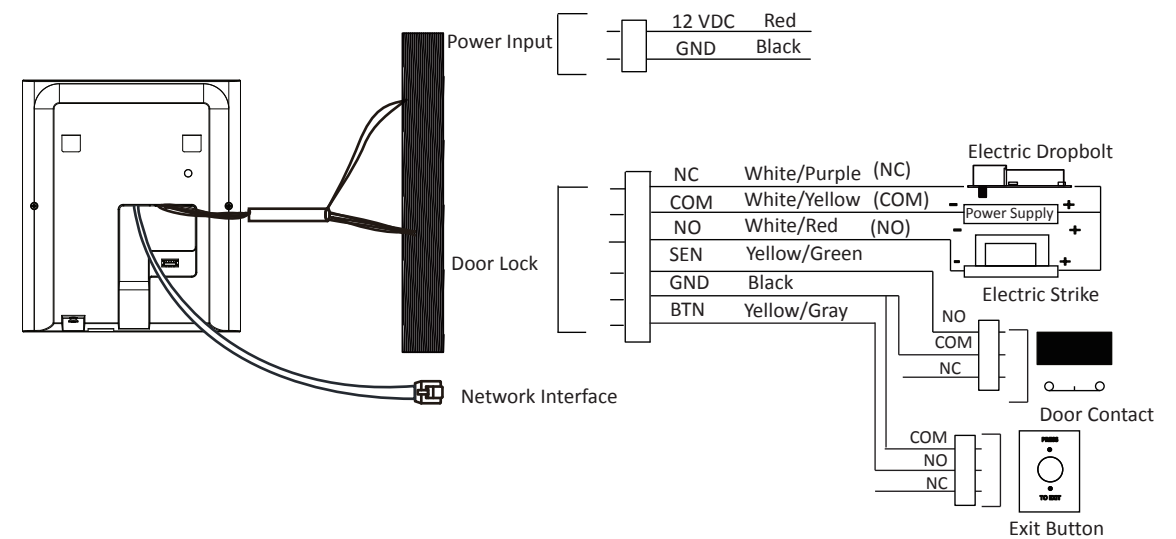

- When connecting door contact and exit button, the device should use the same common ground connection.
- The suggested external power supply for door lock is 12 V, 1 A.
- Do not wire the device to the electric supply directly.



## DS-K1T320 Series Face Recognition Terminal

### Quick Start Guide

UD28736B-B

**About this Document**  
• This Document includes instructions for using and managing the Product. Pictures, charts, images and all other information hereinafter are for description and explanation only.  
• The information contained in the Document is subject to change, without notice, due to firmware updates or other reasons. Please find the latest version of the Document at the Hikvision website (<https://www.hikvision.com>). Unless otherwise agreed, Hangzhou Hikvision Digital Technology Co., Ltd. or its affiliates (hereinafter referred to as "Hikvision") makes no warranties, express or implied.  
• Please use the Document with the guidance and assistance of professionals trained in supporting the Product.

**Acknowledgment of Intellectual Property Rights**  
• Hikvision owns the copyrights and/or patents related to the technology embodied in the Products described in this Document, which may include licenses obtained from third parties.  
• Any part of the Document, including text, pictures, graphics, etc., belongs to Hikvision. No part of this Document may be excerpted, copied, translated, or modified in whole or in part by any means without written permission.  
• HIKVISION and other Hikvision's trademarks and logos are the properties of Hikvision in various jurisdictions.  
• Other trademarks and logos mentioned are the properties of their respective owners.

**LEGAL DISCLAIMER**  
• TO THE MAXIMUM EXTENT PERMITTED BY APPLICABLE LAW, THIS DOCUMENT AND THE PRODUCT DESCRIBED, WITH ITS HARDWARE, SOFTWARE AND FIRMWARE, ARE PROVIDED "AS IS" AND "WITH ALL FAULTS AND ERRORS". HIKVISION MAKES NO WARRANTIES, EXPRESS OR IMPLIED, INCLUDING WITHOUT LIMITATION, MERCHANTABILITY, SATISFACTORY QUALITY, OR FITNESS FOR A PARTICULAR PURPOSE. THE USE OF THE PRODUCT BY YOU IS AT YOUR OWN RISK. IN NO EVENT WILL HIKVISION BE LIABLE TO YOU FOR ANY SPECIAL, CONSEQUENTIAL, INCIDENTAL, OR INDIRECT DAMAGES, INCLUDING, AMONG OTHERS, DAMAGES FOR LOSS OF BUSINESS PROFITS, BUSINESS INTERRUPTION, OR LOSS OF DATA, CORRUPTION OF SYSTEMS, OR LOSS OF DOCUMENTATION, WHETHER BASED ON BREACH OF CONTRACT, TORT (INCLUDING NEGLIGENCE), PRODUCT LIABILITY, OR OTHERWISE, IN CONNECTION WITH THE USE OF THE PRODUCT, EVEN IF HIKVISION HAS BEEN ADVISED OF THE POSSIBILITY OF SUCH DAMAGES OR LOSS.  
• YOU ACKNOWLEDGE THAT THE NATURE OF THE INTERNET PROVIDES FOR INHERENT SECURITY RISKS, AND HIKVISION SHALL NOT TAKE ANY RESPONSIBILITIES FOR ABNORMAL OPERATION, PRIVACY LEAKAGE OR OTHER DAMAGES RESULTING FROM CYBER-ATTACK, HACKER ATTACK, VIRUS INFECTION, OR OTHER INTERNET SECURITY RISKS; HOWEVER, HIKVISION WILL PROVIDE TIMELY TECHNICAL SUPPORT IF REQUIRED.  
• YOU AGREE TO USE THIS PRODUCT IN COMPLIANCE WITH ALL APPLICABLE LAWS, AND YOU ARE SOLELY RESPONSIBLE FOR ENSURING THAT YOUR USE CONFORMS TO THE APPLICABLE LAW, ESPECIALLY, YOU ARE RESPONSIBLE, FOR USING THIS PRODUCT IN A MANNER THAT DOES NOT INFRINGE ON THE RIGHTS OF THIRD PARTIES, INCLUDING WITHOUT LIMITATION, RIGHTS OF PUBLICITY, INTELLECTUAL PROPERTY RIGHTS, OR DATA PROTECTION AND OTHER PRIVACY RIGHTS. YOU SHALL NOT USE THIS PRODUCT FOR ANY PROHIBITED END-USERS, INCLUDING THE DEVELOPMENT OR PRODUCTION OF WEAPONS OF MASS DESTRUCTION, THE DEVELOPMENT OR PRODUCTION OF CHEMICAL OR BIOLOGICAL WEAPONS, ANY ACTIVITIES IN THE CONTEXT RELATED TO ANY NUCLEAR EXPLOSIVE OR UNSAFE NUCLEAR FUEL-CYCLE, OR IN SUPPORT OF HUMAN RIGHTS ABUSES.  
• IN THE EVENT OF ANY CONFLICTS BETWEEN THIS DOCUMENT AND THE APPLICABLE LAW, THE LATTER PREVAILS.

**Data Protection**  
• To protect data, the development of Hikvision Products incorporates privacy by design principles. For example, for Products with facial recognition features, biometrics data is stored in your Products with encryption method; for fingerprint Products, only fingerprint template will be saved, which is impossible to reconstruct a fingerprint image.  
• As a data controller/processor, you may process personal data, including collection, storage, use, processing, disclosure, deletion, etc. You are advised to pay attention to and comply with applicable laws and regulations related to the protection of personal data, including without limitation, conducting security controls to safeguard personal data, such as, implementing reasonable administrative and physical security controls, conduct periodic reviews and the assessments of the effectiveness of your security controls.  
© Hangzhou Hikvision Digital Technology Co., Ltd. All rights reserved.

Scan the QR code to get the user manual for detailed information.



## 4 Quick Operation

### ● Activation via Device

After powering on, you will enter the activation page.

Enter password and press "OK" to confirm password.



● Press "F1" to shift input method.

● Characters containing admin and nimda are not supported to be set as activation password.



**STRONG PASSWORD RECOMMENDED**— We highly recommend you create a strong password of your own choosing (using a minimum of 8 characters, including upper case letters, lower case letters, numbers, and special characters) in order to increase the security of your product. And we recommend you reset your password regularly, especially in the high security system, resetting the password monthly or weekly can better protect your product.

### ● Steps Afterwards

After activating, you can select language, set password change type, set reserved questions, set network parameters, access to Hik-Connect, set privacy, and set administrator.

## 5 Add Face Picture

1. Hold OK and login the device to enter the home page.
2. Select User -> Add User to enter the Add User page.
3. Set the user parameters according to actual needs.  
 Only the device with the fingerprint module support the fingerprint related functions.

4. Select Face and add the face information according to the instructions.  
 You can view the captured picture on the screen. Make sure the face picture is in good quality and size.  
 For details about the tips and positions when collecting or comparing the face picture, see the contents on the right.

5. Press OK to save the face picture. Or press ESC to select Retake and adjust your face position to add the face picture again.

6. Press ESC and then press OK to save the settings.  
 Go back to the initial page to start authentication.  
 For other authentication methods, see the device user manual.

User other authentication methods if the device is affected by the light or other items.

**1:N Matching:** The device will compare the captured face picture with the ones in the database.

**1:1 Matching:** The device will compare the captured face picture with the user linked face picture.



Biometric recognition products are not 100% applicable to anti-spoofing environments. If you require a higher security level, use multiple authentication modes.

### Tips When Collecting/Comparing Face Picture

#### Expression

- Keep your expression naturally when collecting or comparing face pictures, just like the expression in the picture on the right.
- Do not wear hat, sunglasses, or other accessories that can affect the facial recognition function.
- Do not make your hair cover your eyes, ears, etc. and heavy makeup is not allowed.



#### Posture

In order to get a good quality and accurate face picture, position your face looking at the camera when collecting or comparing face picture.

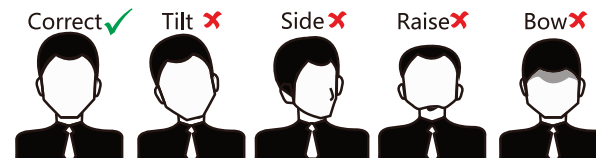

#### Size

Make sure your face is in the middle of the collecting window.

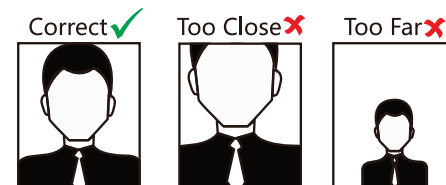

### Positions When Collecting/Comparing Face Picture

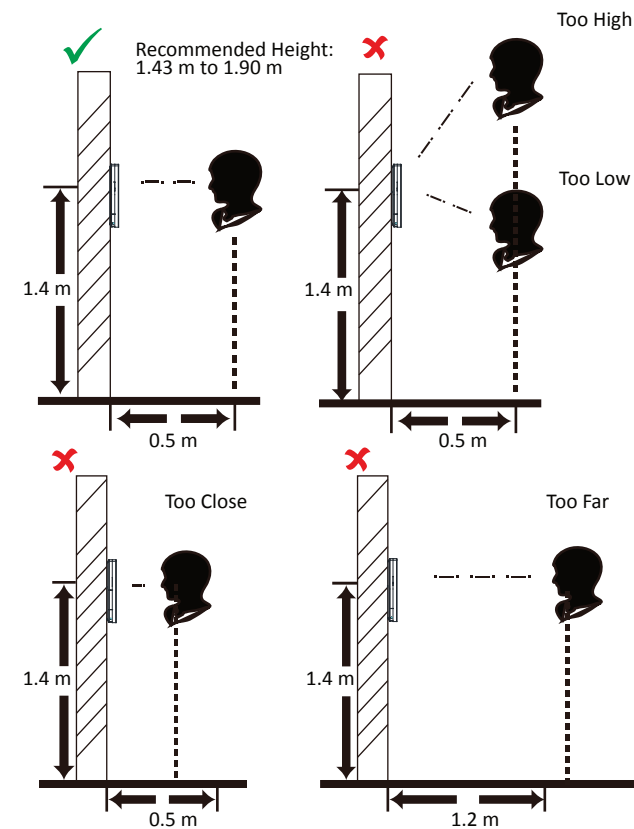

## Regulatory Information

**FCC Information**  
 Please take attention that changes or modification not expressly approved by the party responsible for compliance could void the user's authority to operate the equipment.

**FCC compliance:**  
 This equipment has been tested and found to comply with the limits for a Class B digital device, pursuant to part 15 of the FCC Rules. These limits are designed to provide reasonable protection against harmful interference in a residential installation. This equipment generates, uses and can radiate radio frequency energy and, if not installed and used in accordance with the instructions, may cause harmful interference to radio communications. However, there is no guarantee that interference will not occur in a particular installation. If this equipment does cause harmful interference to radio or television reception, which can be determined by turning the equipment off and on, the user is encouraged to try to correct the interference by one or more of the following measures:  
 —Reorient or relocate the receiving antenna.  
 —Increase the separation between the equipment and receiver.  
 —Connect the equipment into an outlet on a circuit different from that to which the receiver is connected.

—Consult the dealer or an experienced radio/TV technician for help  
 This equipment should be installed and operated with a minimum distance 20cm between the radiator and your body.

**FCC Conditions**  
 This device complies with part 15 of the FCC Rules. Operation is subject to the following two conditions:  
 1. This device may not cause harmful interference.  
 2. This device must accept any interference received, including interference that may cause undesired operation.

**EU Conformity Statement**  
 CE This product and - if applicable - the supplied accessories too are marked with "CE" and comply therefore with the applicable harmonized European standards listed under the EMC Directive 2014/30/EU, RE Directive 2014/53/EU, the RoHS Directive 2011/65/EU



2006/66/EC (battery directive): This product contains a battery that cannot be disposed of as unsorted municipal waste in the European Union. See the product documentation for specific battery information. The battery is marked with this symbol, which may include lettering to indicate cadmium (Cd), lead (Pb), or mercury (Hg). For proper recycling, return the battery to your supplier or to a designated collection point. For more information see: www.recyclethis.info



2012/19/EU (WEEE directive): Products marked with this symbol cannot be disposed of as unsorted municipal waste in the European Union. For proper recycling, return this product to your local supplier upon the purchase of equivalent new equipment, or dispose of it at designated collection points. For more information see: www.recyclethis.info



2012/19/EU (WEEE directive): Products marked with this symbol cannot be disposed of as unsorted municipal waste in the European Union. For proper recycling, return this product to your local supplier upon the purchase of equivalent new equipment, or dispose of it at designated collection points. For more information see: www.recyclethis.info

## Safety Instruction



- Warning**
- In the use of the product, you must be in strict compliance with the electrical safety regulations of the nation and region.
  - Do not connect several devices to one power adapter as adapter overload may cause over-heat or fire hazard.
  - If smoke, odors or noise rise from the device, turn off the power at once and unplug the power cable, and then please contact the service center.
  - The socket-outlet shall be installed near the equipment and shall be easily accessible.
  - 1. Do not ingest battery. Chemical burn hazard!
  - 2. This product contains a coin/button cell battery. If the coin/button cell battery is swallowed, it can cause severe internal burns in just 2 hours and can lead to death.
  - 3. Keep new and used batteries away from children.
  - 4. If the battery compartment does not close securely, stop using the product and keep it away from children.
  - 5. If you think batteries might have been swallowed or placed inside any part of the body, seek immediate medical attention.
  - 6. CAUTION: Risk of explosion if the battery is replaced by an incorrect type.
  - 7. Improper replacement of the battery with an incorrect type may defeat a safeguard (for example, in the case of some lithium battery types).
  - 8. Do not dispose of the battery into fire or a hot oven, or mechanically crush or cut the battery, which may result in an explosion.
  - 9. Do not leave the battery in an extremely high temperature surrounding environment, which may result in an explosion or the leakage of flammable liquid or gas.
  - 10. Do not subject the battery to extremely low air pressure, which may result in an explosion or the leakage of flammable liquid or gas.
  - 11. Dispose of used batteries according to the instructions.



- Caution**
- Do not drop the device or subject it to physical shock, and do not expose it to high electromagnetic radiation. Avoid the equipment installation on vibrations surface or places subject to shock (ignorance can cause equipment damage).
  - Do not place the device in extremely hot (refer to the specification of the device for the detailed operating temperature), cold, dusty or damp locations, and do not expose it to high electromagnetic radiation.
  - Exposing the equipment to direct sun light, low ventilation or heat source such as heater or radiator is forbidden (ignorance can cause fire danger). The device cover for indoor use shall be kept from rain and moisture.
  - Exposing the equipment to direct sun light, low ventilation or heat source such as heater or radiator is forbidden (ignorance can cause fire danger). Please use a soft and dry cloth when clean inside and outside surfaces of the device cover, do not use alkaline detergents.
  - Biometric recognition products are not 100% applicable to anti-spoofing environments.
  - If you require a higher security level, use multiple authentication modes.
  - The serial port of the equipment is used for debugging only.
  - Wall Mounting: Install the equipment according to the instructions in this manual. To prevent injury, this equipment must be securely attached to the floor/wall in accordance with the installation instructions.
  - Improper use or replacement of the battery may result in hazard of explosion. Replace with the same or equivalent type only. Dispose of used batteries according to the instructions provided by the battery manufacturer.
  - This bracket is intended for use only with equipped devices. Use with other equipment may result in instability causing injury.
  - This equipment is for use only with equipped bracket. Use with other (carts, stands, or carriers) may result in instability causing injury.