



Interactive Flat Panel

User Manual

Legal Information

About this Document

- This Document includes instructions for using and managing the Product. Pictures, charts, images and all other information hereinafter are for description and explanation only.
- The information contained in the Document is subject to change, without notice, due to firmware updates or other reasons. Please find the latest version of the Document at the Hikvision website (<https://www.hikvision.com>). Unless otherwise agreed, Hangzhou Hikvision Digital Technology Co., Ltd. or its affiliates (hereinafter referred to as "Hikvision") makes no warranties, express or implied.
- Please use the Document with the guidance and assistance of professionals trained in supporting the Product.

About this Product

- This product can only enjoy the after-sales service support in the country or region where the purchase is made.
- If the product you choose is a video product, please scan the following QR code to obtain the "Initiatives on the Use of Video Products", and read it carefully.



Acknowledgment of Intellectual Property Rights

- Hikvision owns the copyrights and/or patents related to the technology embodied in the Products described in this Document, which may include licenses obtained from third parties.
- Any part of the Document, including text, pictures, graphics, etc., belongs to Hikvision. No part of this Document may be excerpted, copied, translated, or modified in whole or in part by any means without written permission.
- **HIKVISION** and other Hikvision's trademarks and logos are the properties of Hikvision in various jurisdictions.
- Other trademarks and logos mentioned are the properties of their respective owners.
- **HDMI**™ The terms HDMI and HDMI High-Definition Multimedia Interface, and the HDMI Logo are trademarks or registered trademarks of HDMI Licensing Administrator, Inc. in the United States and other countries.

LEGAL DISCLAIMER

- TO THE MAXIMUM EXTENT PERMITTED BY APPLICABLE LAW, THIS DOCUMENT AND THE PRODUCT DESCRIBED, WITH ITS HARDWARE, SOFTWARE AND FIRMWARE, ARE PROVIDED "AS IS" AND "WITH ALL FAULTS AND ERRORS". HIKVISION MAKES NO WARRANTIES, EXPRESS OR IMPLIED, INCLUDING WITHOUT LIMITATION, MERCHANTABILITY, SATISFACTORY QUALITY, OR FITNESS FOR A PARTICULAR PURPOSE. THE USE OF THE PRODUCT BY YOU IS AT YOUR OWN RISK. IN NO EVENT WILL HIKVISION BE LIABLE TO YOU FOR ANY SPECIAL, CONSEQUENTIAL, INCIDENTAL, OR INDIRECT DAMAGES, INCLUDING, AMONG OTHERS, DAMAGES FOR LOSS OF BUSINESS PROFITS, BUSINESS INTERRUPTION, OR LOSS OF DATA, CORRUPTION OF SYSTEMS, OR LOSS OF DOCUMENTATION, WHETHER BASED ON BREACH OF CONTRACT, TORT (INCLUDING NEGLIGENCE), PRODUCT LIABILITY, OR OTHERWISE, IN CONNECTION WITH THE USE OF THE PRODUCT, EVEN IF HIKVISION HAS BEEN ADVISED OF THE POSSIBILITY OF SUCH DAMAGES OR LOSS.
- YOU ACKNOWLEDGE THAT THE NATURE OF THE INTERNET PROVIDES FOR INHERENT SECURITY RISKS, AND HIKVISION SHALL NOT TAKE ANY RESPONSIBILITIES FOR ABNORMAL OPERATION, PRIVACY LEAKAGE OR OTHER DAMAGES RESULTING FROM CYBER-ATTACK, HACKER ATTACK, VIRUS INFECTION, OR OTHER INTERNET SECURITY RISKS; HOWEVER, HIKVISION WILL PROVIDE TIMELY TECHNICAL SUPPORT IF REQUIRED.

- YOU AGREE TO USE THIS PRODUCT IN COMPLIANCE WITH ALL APPLICABLE LAWS, AND YOU ARE SOLELY RESPONSIBLE FOR ENSURING THAT YOUR USE CONFORMS TO THE APPLICABLE LAW. ESPECIALLY, YOU ARE RESPONSIBLE, FOR USING THIS PRODUCT IN A MANNER THAT DOES NOT INFRINGE ON THE RIGHTS OF THIRD PARTIES, INCLUDING WITHOUT LIMITATION, RIGHTS OF PUBLICITY, INTELLECTUAL PROPERTY RIGHTS, OR DATA PROTECTION AND OTHER PRIVACY RIGHTS. YOU SHALL NOT USE THIS PRODUCT FOR ANY PROHIBITED END-USES, INCLUDING THE DEVELOPMENT OR PRODUCTION OF WEAPONS OF MASS DESTRUCTION, THE DEVELOPMENT OR PRODUCTION OF CHEMICAL OR BIOLOGICAL WEAPONS, ANY ACTIVITIES IN THE CONTEXT RELATED TO ANY NUCLEAR EXPLOSIVE OR UNSAFE NUCLEAR FUEL-CYCLE, OR IN SUPPORT OF HUMAN RIGHTS ABUSES.
- IN THE EVENT OF ANY CONFLICTS BETWEEN THIS DOCUMENT AND THE APPLICABLE LAW, THE LATTER PREVAILS.

© Hangzhou Hikvision Digital Technology Co., Ltd. All rights reserved.



Preface

Applicable Models

This manual is applicable to Interactive Flat Panel.

Symbol Conventions

The symbols that may be found in this document are defined as follows.

Symbol	Description
 Note	Provides additional information to emphasize or supplement important points of the main text.
 Caution	Indicates a potentially hazardous situation, which if not avoided, could result in equipment damage, data loss, performance degradation, or unexpected results.
 Danger	Indicates a hazard with a high level of risk, which if not avoided, will result in death or serious injury.

Contents

Chapter 1 Introduction	1
Chapter 2 Operation and Maintenance Precautions	2
2.1 Use of Power Cable	2
2.2 Cleaning and Maintenance	3
Chapter 3 Connection and Installation	4
3.1 Precautions for Installation	4
3.2 Appearance and Interfaces	4
3.2.1 Front Panel and Interfaces	4
3.2.2 Connection to Personal Computer (PC)	7
3.3 Internal Computer Installation	8
3.4 Mounting	9
Chapter 4 Startup and Shutdown	12
4.1 Device Startup	12
4.1.1 Installed Without a Computer Box	12
4.1.2 Installed with a Computer Box	12
4.2 Eco Mode	12
4.3 Shutdown	12
Chapter 5 Menu Operations	14
5.1 Basic Operations	14
5.2 System Bar	15
5.3 Input Source	16
5.4 Network	16
5.5 Control Menu	16
5.5.1 Note	17
5.5.2 Screenshot	19
5.5.3 Vote Machine	19
5.5.4 Random Select	21
5.6 Camera Functions	23
5.6.1 Camera	23
5.6.2 Video	23
5.6.3 Settings	24
Chapter 6 System Settings	25
6.1 Network Settings	25
6.1.1 Wired Network Settings	25
6.1.2 Wireless Network Settings	26
6.1.3 WLAN Hotspot Settings	27
6.2 Display Settings	28
6.3 Audio Settings	30
6.4 Language and Input Settings	30
6.5 Date and Time Settings	30
6.6 Application Management	31
6.7 Bluetooth	32
6.8 Auxiliary Functions	32
6.8.1 Temperature Control	32
6.8.2 Physical Button Settings	33
6.9 Advanced Settings	33

6.10 User Settings	36
6.11 Device Information	38
6.12 Negative Screens	38
Chapter 7 Intelligent Applications.....	39
7.1 FileBrowser	39
7.2 Browser	40
7.3 Whiteboard	40
7.3.1 Toolbar Basic Operations	41
7.3.2 More Tools	42
7.3.3 Manage Whiteboard	48
7.3.4 Save Whiteboard	48
7.3.5 Share Whiteboard	49
7.3.6 More Functions	50
7.4 WonderCastServer	52
7.5 System Pre-installed Applications.....	52
Chapter 8 Appendix A FAQs.....	53

Chapter 1 Introduction

The Interactive Flat Panel (hereafter referred as 'the device') integrates functions of computers, projectors, interactive whiteboards, sound boxes, advertising machines, and so on. The device is empowered by multiple technologies like 4K display, infrared touch, human-machine interaction, multi-media information processing, and network transmission, providing users with various features such as writing, annotating, multi-screen sharing, and remote video call (optional).

The device is mainly used for events including remote video Interactives, trainings and guidance, medical consulting, and others in places of offices, meeting rooms, multi-media classrooms, exhibition halls, and so on.

Key Features

- Ultra HD display with up to 3840 × 2160 resolution of input signal available.
- 20px ultra fine writing, and 2 mm diameter recognizable with the precision of 1 mm.
- Supports USB 3.0.
- Built-in Wi-Fi realizes screen mirroring without any cable connection.
- Built-in interactive whiteboard system allows annotating and sharing by QR code.
- Looping-out display available.
- Various audio and video interfaces for device access.
- Built-in network switch module saves a network switch.
- Built-in Android system provides kinds of applications.
- Compatible with OPS/OPS-C devices, realizing smooth switch between built-in systems.
- Ultra-thin design with aluminum profile frame.

Chapter 2 Operation and Maintenance Precautions

The LCD panel on the device is made by high-precision technology. However, tiny spots on the screen that are always or never lit may be observed, or when observed from side, the color and brightness may appear to be uneven. Yet the above phenomena are common among LCD displays rather than faults and will not affect the performance of the device.

- Our company is not responsible for any fault caused by third-party when operating the device and other failure or damage incurred.
- Do not operate the device in an environment of dust, high humidity, or oil and steam contacting to avoid the risk of fire and damage.
- Do not place the device under direct sunlight or near strong light source.
- Do not place the device near other equipment with strong radiation.
- Do not expose the device to rain or humid environment.
- Do not place the device on unstable or unsafe surface. Avoid strong impact, vibration or vibration.
- Do not operate the device near heating device or place of high temperature to avoid the risk of fire.
- After moving the device from low temperature environment to high temperature environment, please do not turn on the device immediately and wait for the condensation to evaporate.
- Do not insert any object into the device.
- Do not place heavy objects upon the device.
- The device and its accessories are subject to change without prior notice.
- The fragile materials of the display are vulnerable to falling and impact. Please hold with care.
- Improper operations during debugging and operating may cause damage to the device.
- Scratching or knocking the device with hard objects is strictly forbidden. Do not frequently turn on/off the power of the device when operating to avoid the risk of damage and faults.
- If smoke, odor or noise rise from the device, turn off the power at once and unplug the power cable, and then please contact the service center.

2.1 Use of Power Cable

- If the power cable is damaged or failed, contact service center. Make sure the power supply is properly grounded and matches the requirements specified by the plate on the shell.
- Do not expose the device to rain or humid environment. Disconnect power plug and antenna in thunderstorm weather.

- If the device will not be used for a long time. Shut down the power of the device and disconnect the power supply.
- Electric discharge may last for a short period of time after the power is shut down. Please wait for two minutes after the power shut down to operate the device.
- Only use the original power cable delivered with the device. Contact authorized dealer to purchase power cable with same specifications.
- Make sure the power supply is grounded.
- Do not let dust or metal attachment adhere to the power plug and socket.
- Do not modify the cable in any form.
- Do not place heavy object on the cable.
- Keep the cable away from heat.
- Do not disconnect the power plug by pulling the cable.
- Keep the power cable away from physical or mechanical damage.
- The cable is applicable only to the Interactive Display. Do not use it on other devices.

2.2 Cleaning and Maintenance

- The hole on the rear shell is for heat dissipation. Do not pour or spray liquid to the rear shell or use wet cloth for cleaning.
- Disconnect the power plug before cleaning.
- Do not display images with high brightness on the screen for too long.
- Use a dry, soft and dust-free cloth to clean the device.
- Contact service center for internal cleaning.
- Proper maintenance can avoid certain early-stage failures.
- Clean the device on a regular basis to make the device look new.
- Do not clean the device with water, spray cleaner or industrial chemical reagent. Prevent foreign matters from entering the device.
- Contact qualified service personnel for device maintenance. If the device is damaged, please contact our company, do not carry out unauthorized maintenance.

Chapter 3 Connection and Installation

3.1 Precautions for Installation

- Clean the device screen and back before installation for best performance.
- For safety, only use the wall mount or base provided by the manufacturer.
- Contact professional staff for wall mounting.
- Check the accessories before the installation. Contact the dealer if anything is missing.
- Do not install the device too tight. Otherwise the screen may be distorted.
- Mount the device on load-bearing wall.
- Place the device on a stable surface or fix the device steadily on the wall.
- Install the device near an available AC power socket for easy power connection. Use the same ground cable with other devices to prevent signal interference.
- Do not place the device near mechanical vibration source.
- Do not place the device in an environment where insects have easy access.
- Do not let the device face the air conditioner directly to avoid condensing.
- Do not place the device in strong electromagnetic field to avoid radio interference.

3.2 Appearance and Interfaces

3.2.1 Front Panel and Interfaces

The interfaces of Interactive Flat Panel are shown as followed.



- Interfaces of the device vary from different types.
- The following description is from the direction facing the screen.



Figure 3-1 Front Panel and Interfaces

Table 3-1 Panel Description

No.	Description	No.	Description
1 (From Left to Right)	HDMI input interface Multi-functional USB interface Multi-functional USB interface Multi-functional USB interface Type-C interface Light sensor Remote-control unit	2	NFC Operations refer to Unlock Card in 6.10 User Settings .
3 (From Left to Right)	Power key Volume – Volume + Android host menu Return Control menu Physical Button (Switch to PC by default. Custom operations refer to 6.8.2 Physical Button Settings)	4	Power switch
5	Power supply AC 100 ~ 240 V	6	Multi-functional USB interface
7	Android USB interface	8	HDMI 1 input interface
9	LAN 1 interface	10	LAN 2 interface
11	Peripheral touch interface	12	Serial port interface
13	Audio input interface	14	Audio output interface

3.2.2 Connection to Personal Computer (PC)

The connection of PC and the device is shown as below.

 **Caution**

The device must be disconnected from power supply before installation or disassembly.

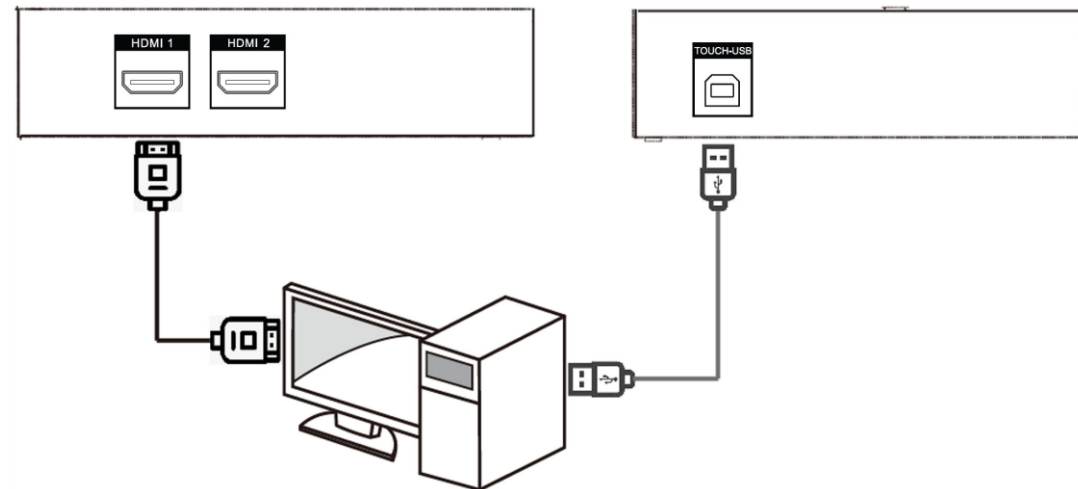

Figure 3-2 Connect to PC

 **Note**

- The Touch-USB interface is needed only when the user needs to touch operate the external PC on the device.
- Use high quality signal cable less than 10 meters in length for high HDMI signal transmission quality.
- USB cable is not contained in the product. Please purchase USB cable with Type-A connector to Type-B connector.

3.3 Internal Computer Installation

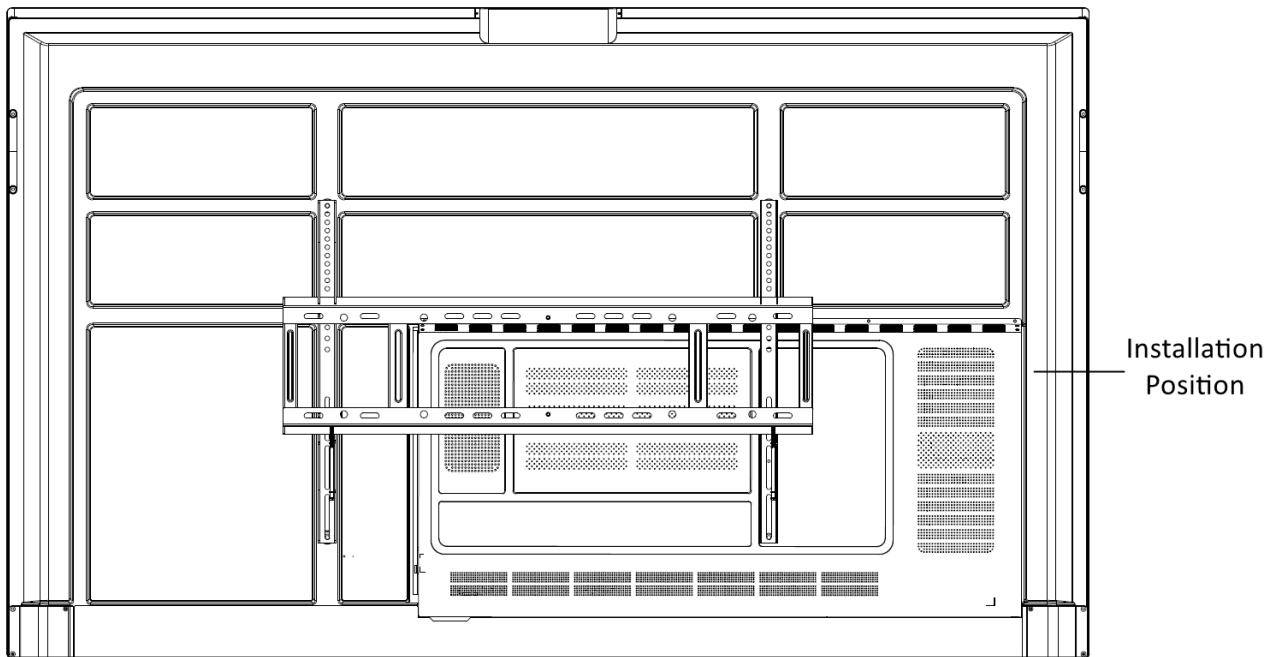

Figure 3-3 Internal Computer Installation

The computer box is installed at the side slot of the device. When installing the box, make sure its ventilation hole is facing the same direction with the rear panel as shown above. Fasten the screws to fix the box into position.

 **Danger**

- The computer is an optional accessory.
- To avoid potential device damage, the computer box can be removed only after the device is disconnected from power.

3.4 Mounting

The device can be installed with wall mount or mobile mount, as shown below.

 **Note**

The accessories for wall mounting and mobile mounting are different. Do not mix them up.

Wall Mounting

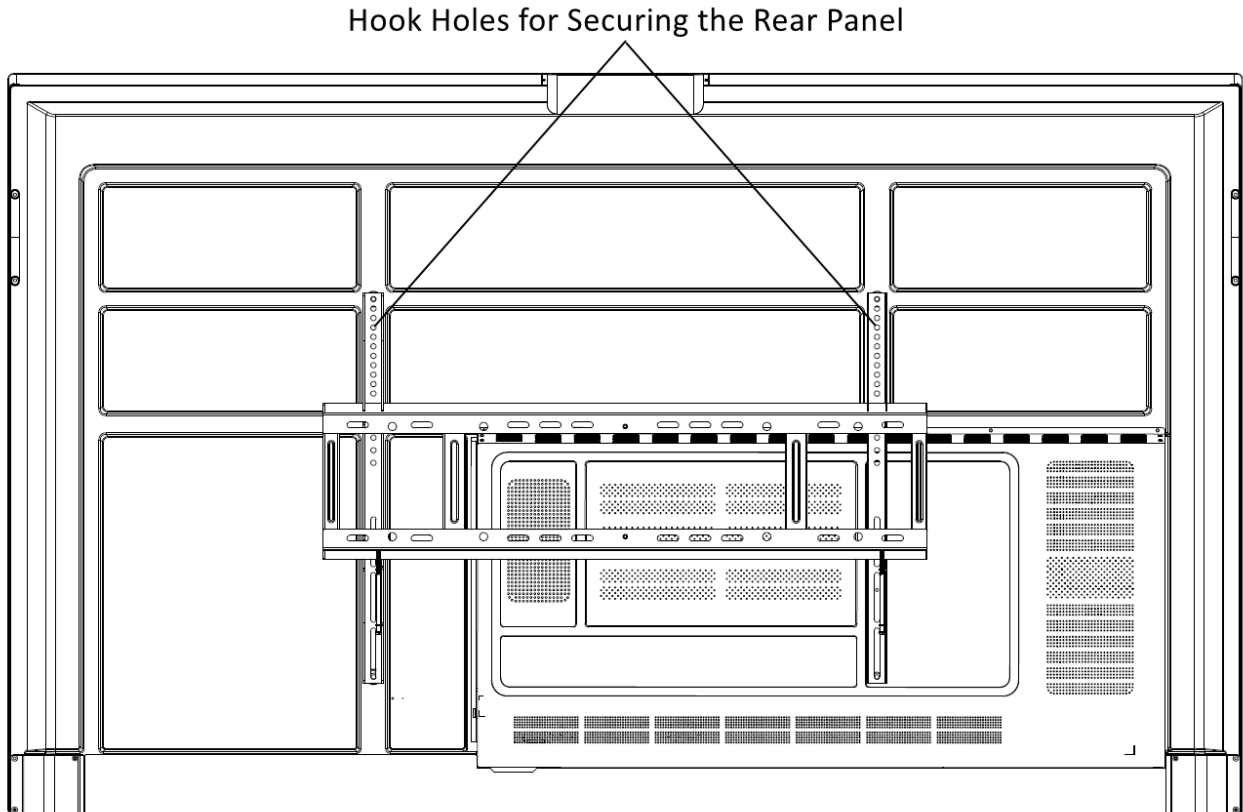

Figure 3-4 Wall Mounting Rear View

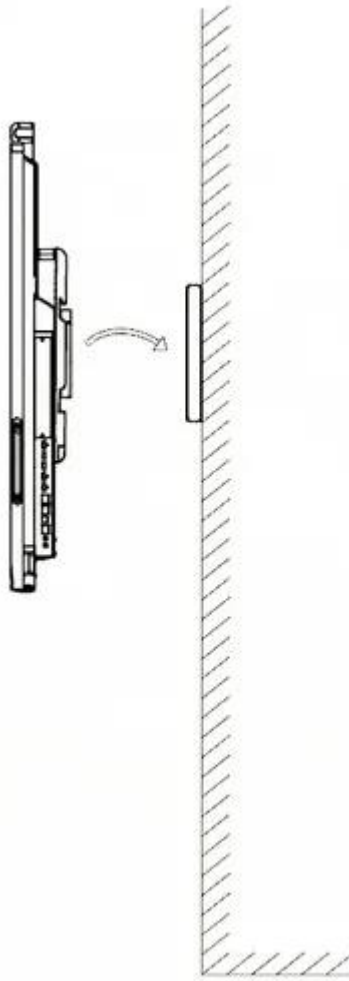

Figure 3-5 Wall Mounting Side View

 **Note**

The wall mounting is mobile horizontally. Please leave a space no less than 6 cm at each side (or 12 cm at one side), and 5 mm at the top and bottom for maintenance service.

Mobile Mounting

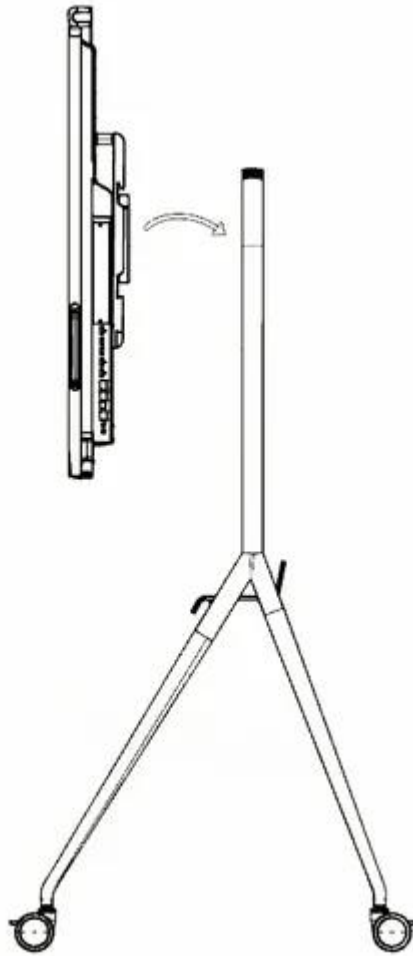

Figure 3-6 Mobile Mounting

Chapter 4 Startup and Shutdown

4.1 Device Startup

4.1.1 Installed Without a Computer Box

Steps

Step 1 Connect the device to power supply.

Step 2 Turn on the power switch, and the power indicator on the front panel will turn red.

Step 3 Push the power button on the front panel to start up the device, the indicator will turn blue.

4.1.2 Installed with a Computer Box

Install the box when the device is disconnected from power and turn on the power switch after the installation is finished. During the startup, the power indicator of the box will turn red and the fan will start. After a beep sound, the power indicator will turn green and the computer is switched on. Meanwhile, the power indicator on the front panel will turn blue which means the device is switched on.

4.2 Eco Mode

Entering Eco Mode

Press the power button on the front panel to turn off the screen and enter Eco Mode.

Waking up the Device

Four ways to wake up the device:

- Press the power button on the front panel.
- Press the power-off button on the remote control.
- Touch anywhere on the screen twice.

4.3 Shutdown

- If the device is not installed with a computer box or the computer box is shut down, directly switch off the power to shut down the device.
- If the device is installed with a computer box which is powered on, tap **Start** and choose **Shutdown**, or press the power button on the computer box to shut it down (press and hold the power button to force shutdown). Then switch off the power to shut down the device.

 **Note**

Switching off the power of the device directly leads to force shutdown of the computer box. Next time the device starts up, Windows may enter error recovery mode and screen touch will be disabled. In this case, you need to connect a mouse and a keyboard to the device.

- Press and hold the power-off button on the remote control.

Chapter 5 Menu Operations

Note

Software interfaces and functions may vary with device models. All pictures in this manual are for illustration purpose only.

Turn on the device and go to the main page. The shortcut menu is displayed at the bottom of the screen.

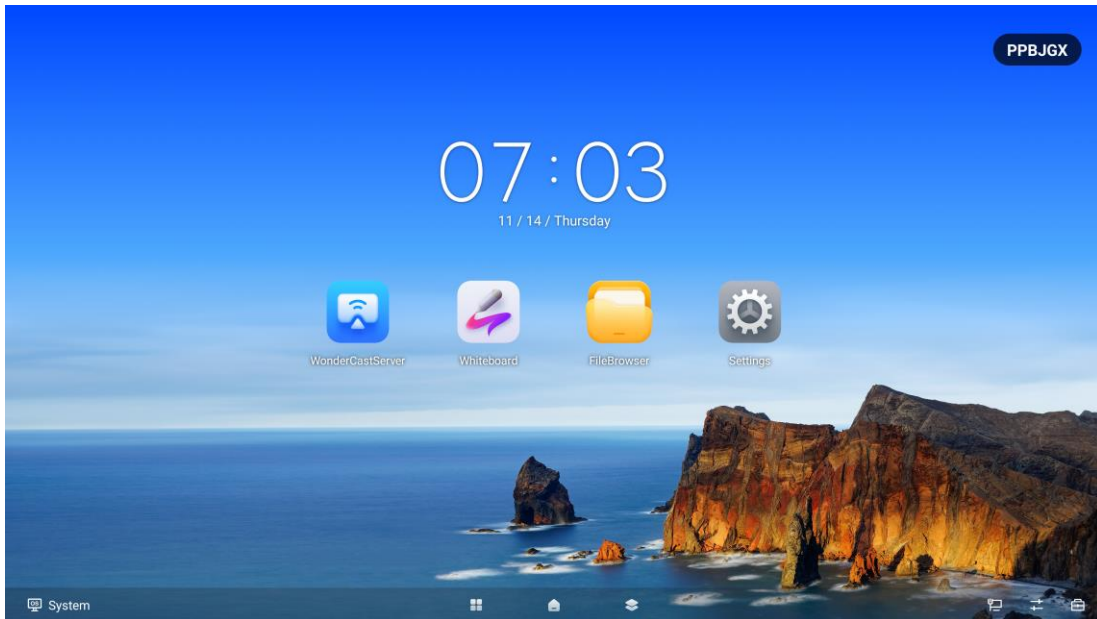

Figure 5-1 Main Page

Note

Press and hold the icons of applications on the main page to realize the following operations:

- Move applications cross screen.
- Merge applications into folders with other applications.

5.1 Basic Operations

Functions of the shortcut icons are described below.



Figure 5-2 Shortcuts

Table 5-1 Shortcuts Description

No.	Function	No.	Function
1	Tap to hide the menu bar at the bottom.	6	Tap to check or clear all the apps of processes.
2	Tap to return to the previous page.	7	Tap to configure network parameters and hotspot.
3	Tap to select the input source.	8	Tap to configure brightness and volume.
4	Tap to check all the applications. Press and hold to move the selected application to display in split-screen mode or window mode.	9	Tap to open the control menu.
5	Tap to return to the main page.	/	/

Note

Up to 20 pens are allowed when lines with angled stroke is disabled, while only one when enabled. After the bottom bar menu is hidden, it can be called out through .



Figure 5-3 Call Out Bottom Bar

5.2 System Bar

Press and hold the area of system bar to modify the layout of apps in the system bar.

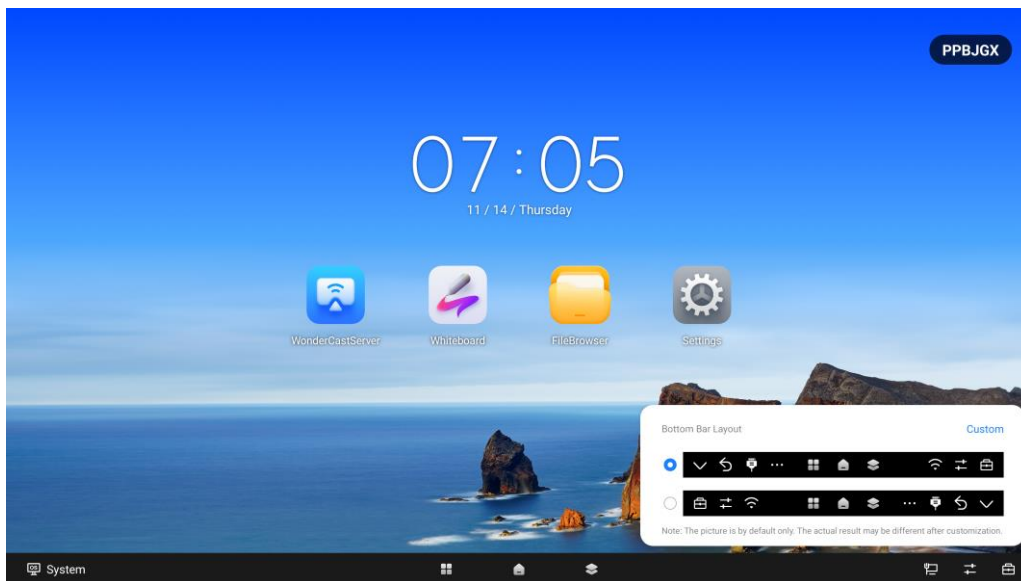

Figure 5-4 Layout of System Bar

Click **Customize**, and move an icon to adjust its position.

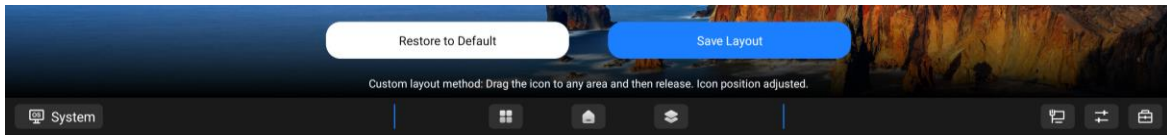

Figure 5-5 Customize the Layout of System Bar

5.3 Input Source

Tap the icon of input source at the bottom, and set the input source of the device. **System**, **HDMI 1**, **HDMI 2**, **Type-C**, **DP**, and **VGA** are available.

5.4 Network

Set the detailed parameters of wired network, wireless network, and WLAN hotspot. Refer to **Network Settings** for more details.

5.5 Control Menu

Tap  at the bottom to show the control menu. The following operations are available.

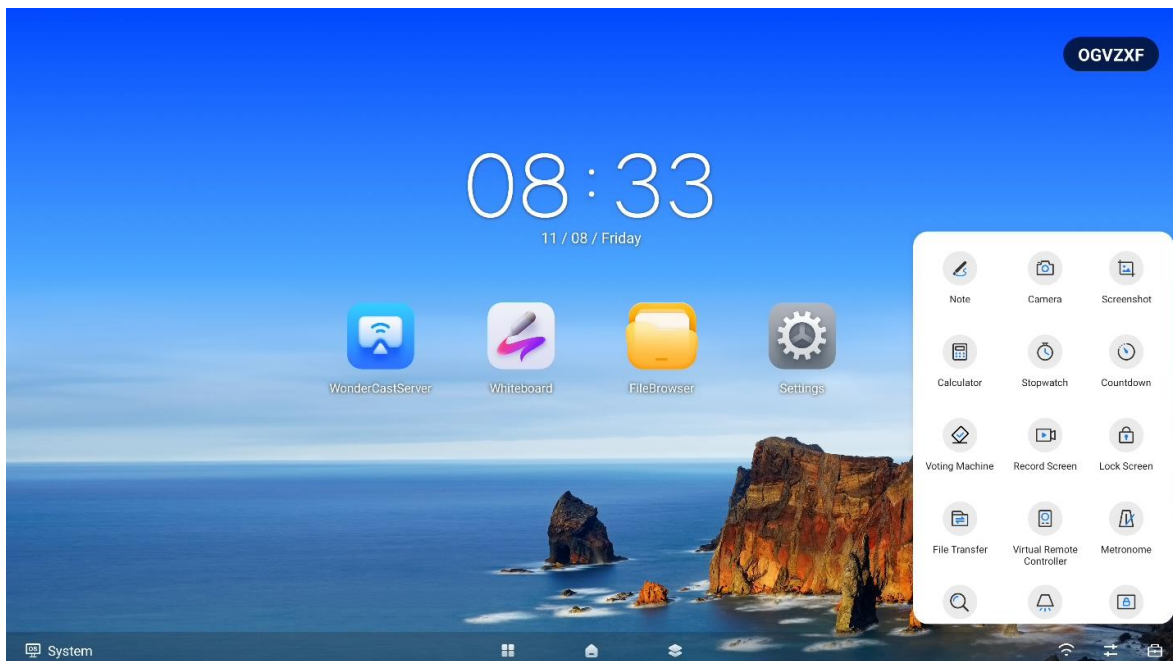



Figure 5-6 Control Menu

Table 5-2 Control Menu Descriptions

Tool	Description
Note	Take annotations on the current page.
Camera	Open the camera bound to the device.
Screenshot	Capture the current page.
Calculator	Enable the built-in calculator.
Stopwatch	Measure the amount of time.
Countdown	Count seconds backwards to zero.
Voting Machine	Set vote settings to vote.
Record Screen	Record the screen as a video.
Lock Screen	Tap to enable touch lock, and no touch operation on the locked page is available. Tap the lock and exit, the touch function will return to normal.
File Transfer	Transfer files.
Virtual Remote Controller	Enable the virtual controller. The hovering display remote control menu supports up, down, left, right, confirm, return and home buttons, and the hovering virtual remote control position can be moved.
Metronome	Tap to see the Metronome. After tapping the start button, beat can be heard. The notes and beat can be adjusted.
Magnifier	Tap the Magnifier. Then touch the screen to see a zooming circle and move to see details. The size of the circle can be adjusted.
Spotlight	Tap to enable an aperture. The brightness and the size can be adjusted.
Freeze Screen	Freeze the current page.
Black Screen	Tap to turn off the screen.
Calendar	Check the date information.
Piano	A virtual piano tool.
Random Select	Set number of options to select one randomly.

5.5.1 Note

Go to  → **Note** to take notes. You can add notes anywhere on the page by touching and moving on the screen.

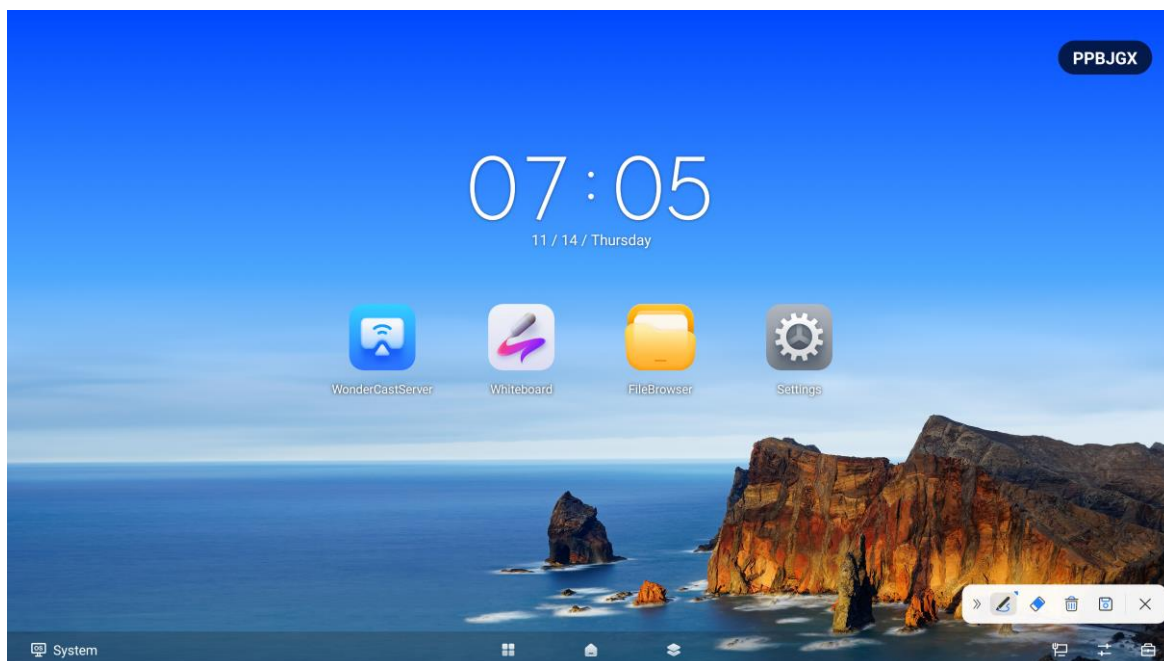









Figure 5-7 Take Notes

Table 5-3 Icon Descriptions

Icon	Description
	Pen color and size are customizable. Enable angled stroke or not. Tap  to have lines with angled stroke, and tap  to have lines without angled stroke.
	Erase the desired notes.
	Clear all the notes.
	Save the current page. Generate QR code of notes when flat panel connects to the LAN. Devices in the same LAN can scan the QR code to download notes.
	Exit note.
	Collapse/Expand note toolbar.

 **Note**

Up to 20 pens are allowed when lines with angled stroke is disabled, while only one when enabled.

5.5.2 Screenshot





Go to  → **Screenshot**, and a capture area pops up on the current page. Adjust the area by tapping and dragging the four corners. The screenshot toolbar pops up on the lower right corner of the area.



Figure 5-8 Screenshot

Table 5-4 Screenshot Toolbar Descriptions

Icon	Description
	Exit screenshot.
	Capture the whole page.
	Generate QR code from the screenshot, and devices in the same LAN can scan the QR code to download the screenshot.
	Save the screenshot in the capture area.

5.5.3 Vote Machine

After the flat panel is connected to the public network, click **Vote** in the Control Menu. You can choose quick vote or vote according to options have been set.

Before You Start

Make sure the device is connected to the network.

Quick Vote

Steps

Step 1 Click **Quick** to select the number of voting options.

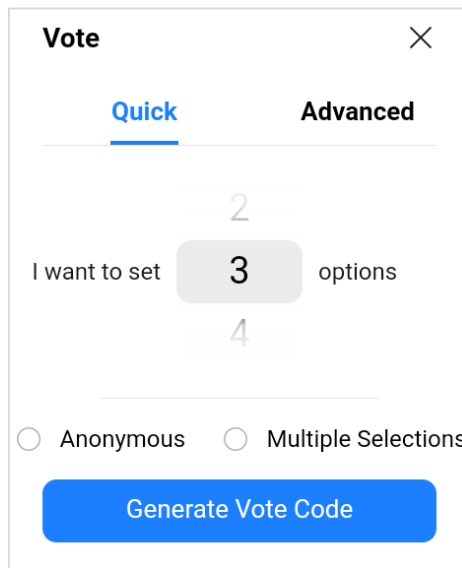

Figure 5-9 Quick Vote

Step 2 Configure the following parameters according to the actual needs.

- Anonymous: Vote without name.
- Multiple Selections: Select multiple-options when voting.

Step 3 Click **Generate Vote Code** to vote through scanning the code by mobile phone.

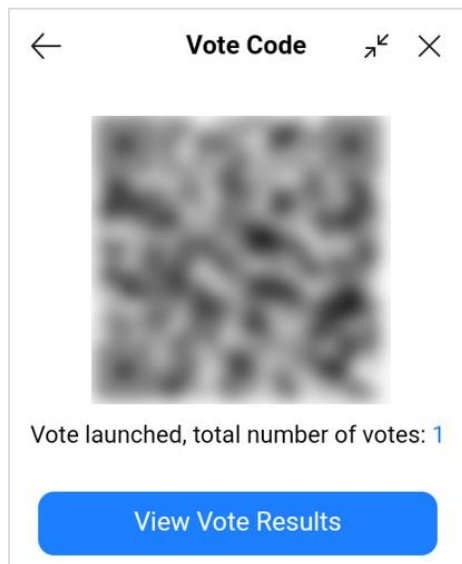

Figure 5-10 Vote by Mobile Phone

Step 4 Click **View Vote Results** to end voting and check the details.

Step 5 Optional: Click **Scan to Download** to download the voting results through mobile phone.

Advanced Vote

Steps

Step 1 Click **Advanced** to set the vote through scanning QR code by mobile phone.

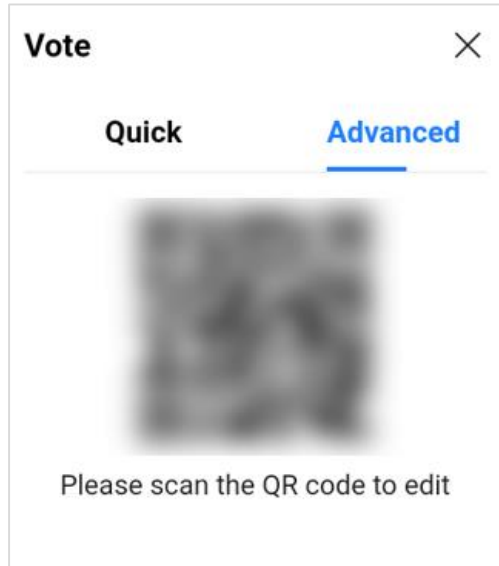

Figure 5-11 Advanced Vote

Step 2 Configure the following parameters according to the actual needs.

- Vote Theme/Vote Options: Custom configuration.
- Anonymous: Vote without name.
- Multiple Selections: Select multiple-options when voting.

Step 3 Click **Launch Vote** to vote through scanning code by mobile phone.

Step 4 Click **View Vote Results** to end voting and check the details.

Step 5 Optional: Click **Scan to Download** to download the voting results through mobile phone.

5.5.4 Random Select

In the classroom, you can initiate lucky draw or randomly select a student to answer questions.

Steps

Step 1 Go to  → **Random Select**, and set the number of options. Click **Next**.

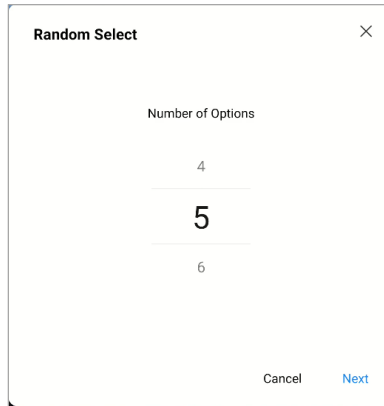



Figure 5-12 Set Number of Options

Step 2 Click  to start spinning the lucky wheel, and click again to stop. Then you will see the randomly selected option.

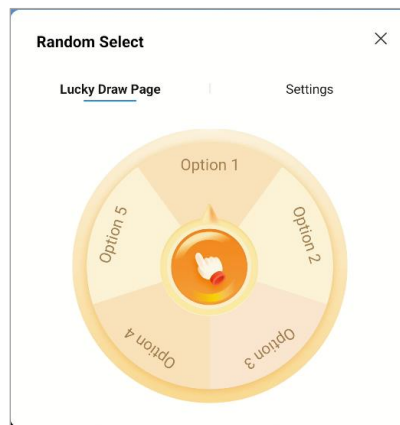

Figure 5-13 Lucky Wheel

 **Note**

Tap **Settings**, and you can edit the name of options.

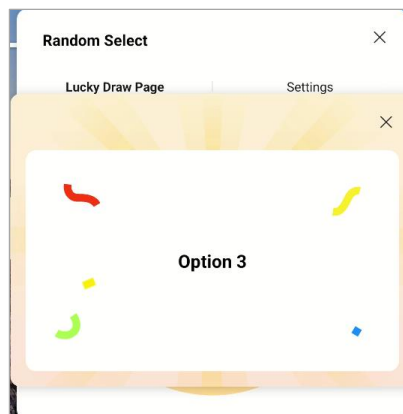

Figure 5-14 Selected Option

5.6 Camera Functions

5.6.1 Camera

Click **Camera** to take a photo or video.

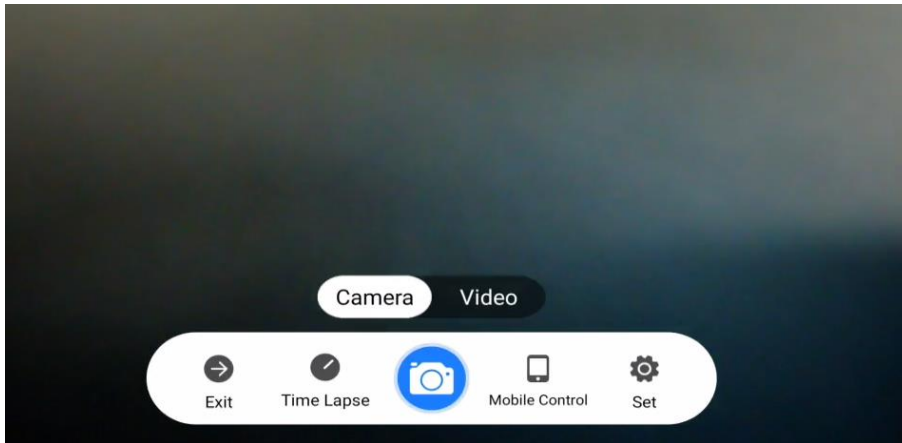

Figure 5-15 Camera

Table 5-5 Screenshot Toolbar Descriptions

Icon	Description
	Exit camera.
	Delay taking pictures according to the selected delay time.
	Take photos. You can import the photos to the whiteboard or save them to your phone.
	After the mobile phone and the device are connected to the same LAN, you can control the camera to take photos by scanning the code.

5.6.2 Video

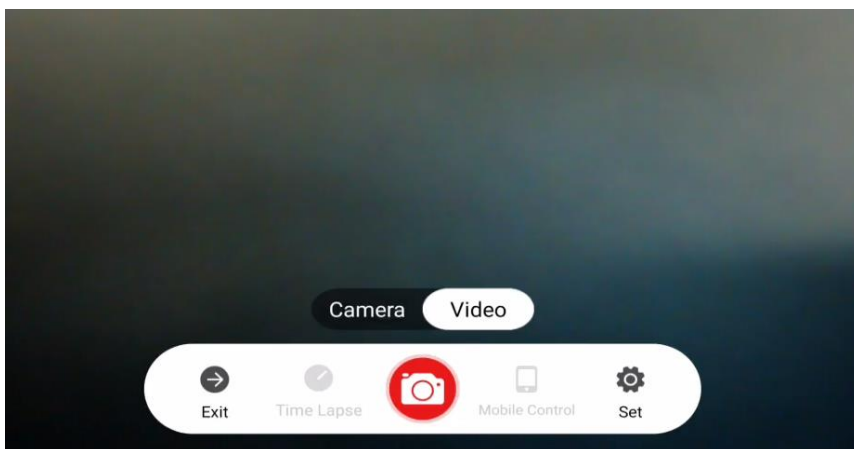



Figure 5-16 Video

Table 5-6 Screenshot Toolbar Descriptions

Icon	Description
	Exit video.
	Start recording.

5.6.3 Settings

Click **Settings** to configure the following parameters.

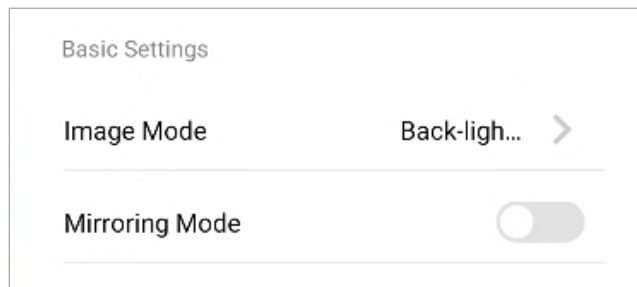

Figure 5-17 Set Camera

Image Mode

Click to select image mode, including **Standard**, **Vivid**, and **Back-lighting**.

Mirroring Mode

Enable to mirror the camera's image.



Chapter 6 System Settings

The screen displays the main page after the device is turned on. Slide the screen to the left or right to view applications, device status, and help documents.

6.1 Network Settings

The network status is displayed at the bottom of the screen.

Table 6-1 Different Network Status

Icon	Description
	Connected to a wired network.
	Connected to a wireless network.
	No network connected.

6.1.1 Wired Network Settings

Steps

Step 1 Go to **Settings** → **Network** → **Wired Network**.

Step 2 Enable **Wired Network**.

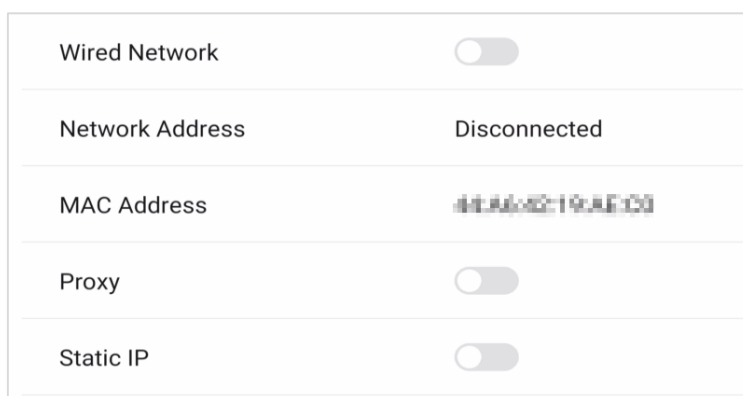

Figure 6-1 Wired Network Settings

Step 3 Optional: Tap to enable **Proxy** or **Static IP**.

Proxy Settings

When proxy enabled, you need to set **Proxy Host** and **Port No.**, and set the URLs that do not use the proxy.

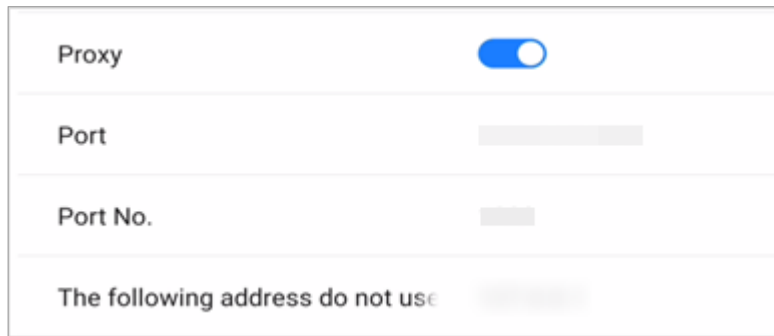

Figure 6-2 Proxy Settings

Static IP Settings

When static IP enabled, you need to set network parameters, such as **Static IP**, **Gateway**, **Subnet Mask**, **DNS1**, and **DNS2**.

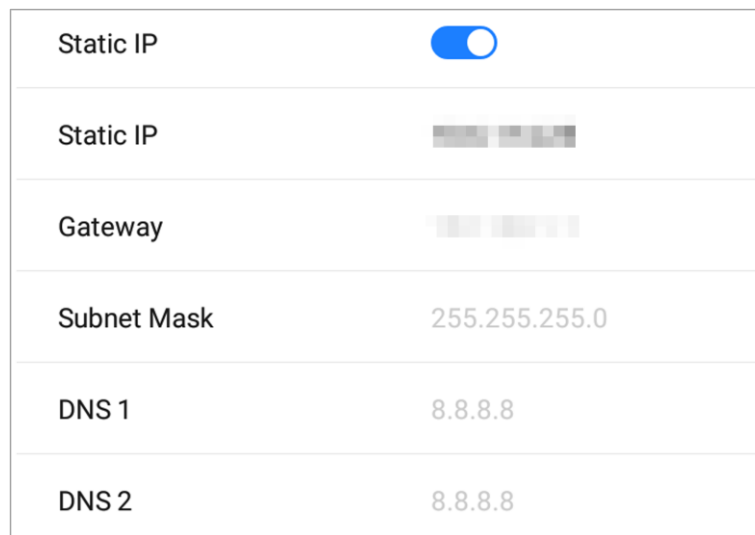

Figure 6-3 Static IP Settings

6.1.2 Wireless Network Settings

Steps

Step 1 Go to **Settings** → **Network** → **Wireless Network**.

Step 2 Enable WLAN, and you can add a new network or connect to an available network.

Connect to Available Networks

- Tap the desired network in the available network list, and enter the password to connect.
- Tap **Connect**, and network information page pops up. Tap **Clear Network** to delete the information of the selected network. Tap **Cancel** to exit the page.

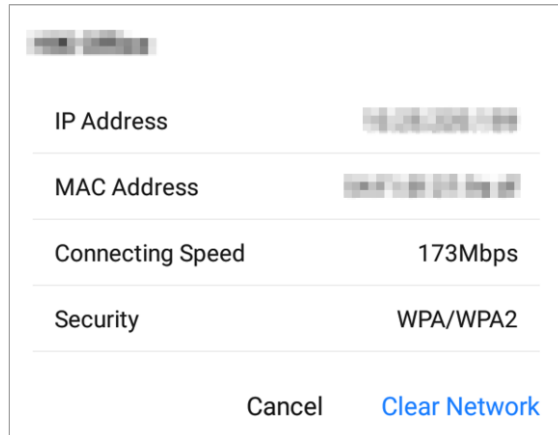

Figure 6-4 Wireless Network Information

Add Other Networks

Steps

Step 1 Tap **Add Other Networks**.

Step 2 Enter Wi-Fi name and select **Security**.

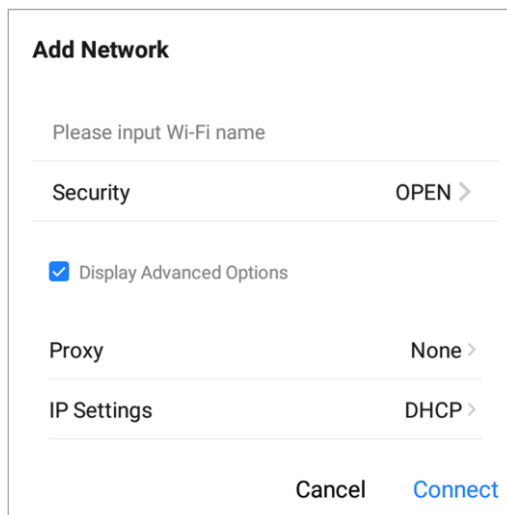

Figure 6-5 Add Other Network

Step 3 Optional: Check **Display Advanced Settings** to select proxy and network IP type.

Step 4 Tap **Connect** to connect the device to the added wireless network.

6.1.3 WLAN Hotspot Settings

When the device is connected to the wired network, it can provide wireless network for other devices with WLAN hotspot enabled.

Steps

Step 1 Go to **Settings** → **Network** → **Hotspot**.

Step 2 Enable **Portable WLAN Hotspot**.

Hotspot Isolation: After enabling hotspot isolation, even if the device is connected to the LAN, it cannot access resources such as websites in the LAN.

Step 3 Set parameters in the pop-up page.

Portable WLAN Hotspot	<input checked="" type="checkbox"/>
Device Name	Please input network SSID
Security	WPA2 PSK >
Password	•••••••• 
AP Frequency	5 GHz >
AP Channel	153 >
Hotspot Isolation	<input type="checkbox"/>

Figure 6-6 Hotspot Settings

 **Note**

If the device supports both 2.4 GHz and 5 GHz, set 5 GHz as **AP Frequency**, and recommended channels as **AP Channel** for better experience functions such as wireless screen mirroring.

6.2 Display Settings

Go to **Settings** → **Display** to adjust parameters, such as brightness and sleeping time.

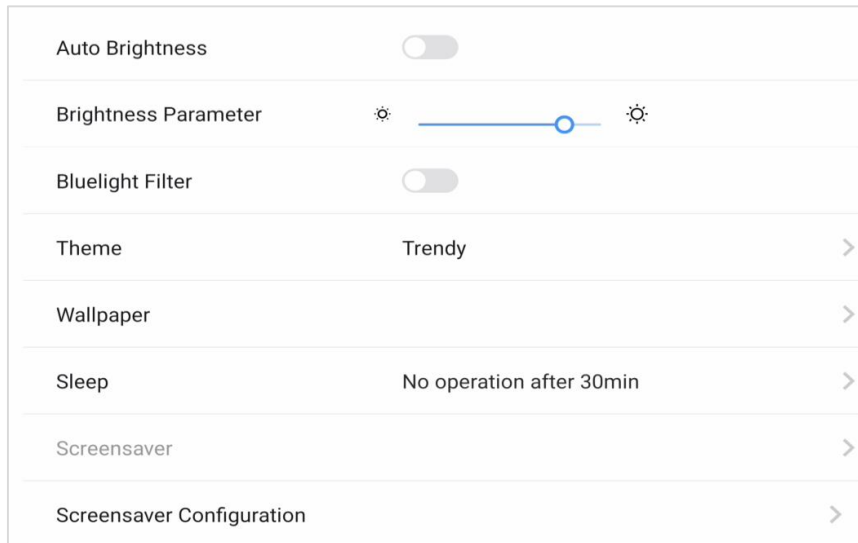

Figure 6-7 Display Settings

Auto Brightness

The device can adjust brightness according to the environment automatically when enabled.

Brightness Parameter

Slide the slider to adjust the brightness of the screen.

Bluelight Filter

Enable the function to protect your eyes by filtering blue light.

Theme

Set the device theme. Tap **Settings** to select a desired theme, and tap **Apply**.

Wallpaper

Tap **Wallpaper** to select a desired picture from wallpaper library or the system picture library as wallpaper, or restore to the default wallpaper.

Sleep

Set an inactivity period for sleep mode.

Screensaver

Set an inactivity period for enabling screensaver.

Screensaver Configuration

Tap to select a screensaver picture in the pop-up page, and tap **Live View** to preview the effect. Tap **Apply** to set the selected picture as the screensaver. The screensaver can also be customized.

 **Note**

You can add new screensaver pictures in **Screensaver Configuration** by tapping **+**.

6.3 Audio Settings

Steps

Step 1 Go to **Settings** → **Audio** to set audio parameters.

Step 2 Select **Audio Mode** based on the actual installation method.

- Normal Mode: With bass, the sound is natural;
- Meeting Mode: Focusing on clear vocals, reducing bass, default meeting mode.

Step 3 Adjust the **Volume** value.

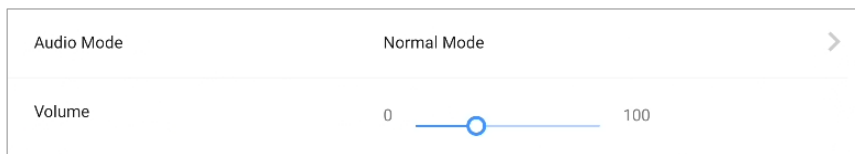

Figure 6-8 Audio Settings

6.4 Language and Input Settings

Steps

Step 1 Go to **Settings** → **Language & Input**.

Step 2 Tap **Language** to select the desired language.

Step 3 Tap **Input Method** to select the desired input method.

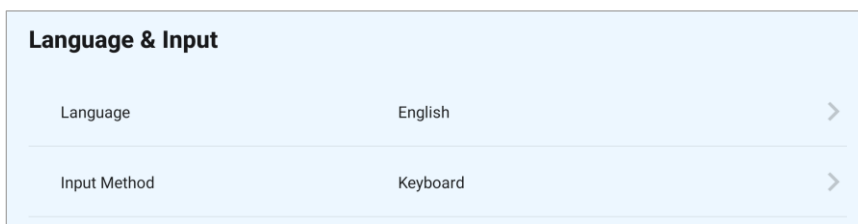

Figure 6-9 Language and Input Settings

6.5 Date and Time Settings

Steps

Step 1 Go **Settings** → **Date & Time**.

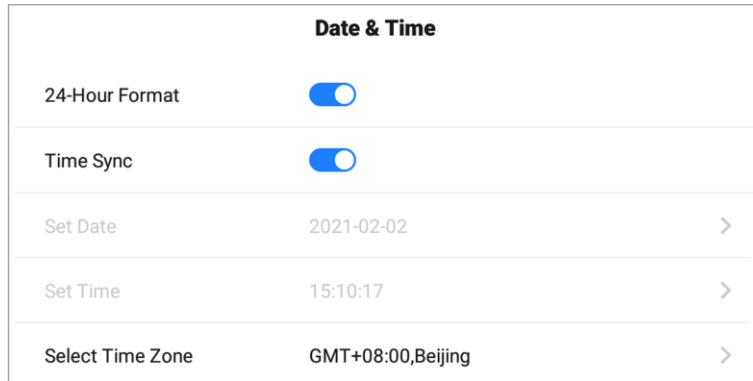

Figure 6-10 Date and Time Settings

Step 2 Enable **Time Sync**.

Step 3 Tap **Select Time Zone** to select the region.

Step 4 Optional: Enable **24-Hour Format** to display the time in 24-hour format.



Note

If **Time Sync** is disabled, you can set date and time manually.

6.6 Application Management

Steps

Step 1 Go to **Settings** → **Application Management**.

Step 2 Tap the desired application to check details.

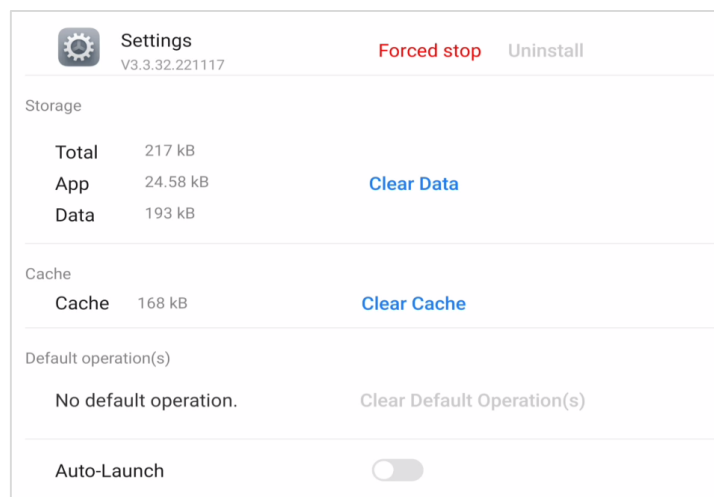

Figure 6-11 Application Details

 **Note**

- The built-in applications cannot be uninstalled. You can tap the icon in **Application Details** to open the application.
- After the third-party application is installed, the 4K display can be enabled (effective after the equipment is restarted).

Step 3 Enable **Auto-Launch**. The selected application will be started automatically when the device is powered on.

6.7 Bluetooth

The remote control, audio, keyboard, etc. can be connected through Bluetooth, and file transfer can also be performed.

Enable **Bluetooth** to search the available devices nearby, and tap the desired one to connect.

6.8 Auxiliary Functions

6.8.1 Temperature Control

The device monitors inner temperature in real time. When the temperature exceeds the set warning or alarming temperature, the device will display prompt messages for you to take measures in a timely manner.

Steps

Step 1 Go to **Settings** → **Auxiliary Functions** → **Temperature Control**.

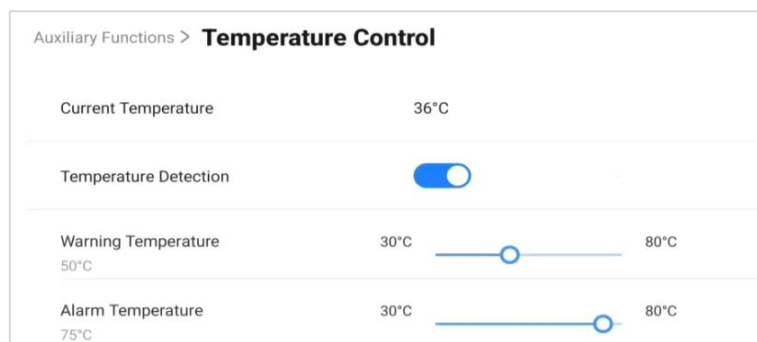

Figure 6-12 Intelligent Temperature Control

Step 2 Enable **Temperature Detection**.

Step 3 Slide the slider to set Warning Temperature and Alarming Temperature.

 **Note**

When the temperature exceeds the set alarming temperature, the temperature information pops up and prompts you to turn off the device.

6.8.2 Physical Button Settings

The function of Physical Button can be customized.

Steps

Step 1 Go to **Settings** → **Auxiliary Functions** → **Physical Button Settings**.

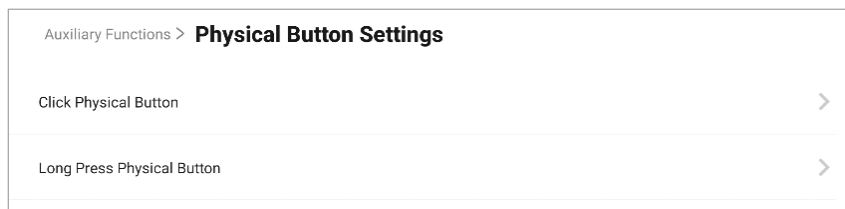

Figure 6-13 Physical Button Settings

Step 2 Tap **Click Physical Button** to set one of the following functions: OPS Switch, Quick Recording, Quick Open Whiteboard, Switch to PC, or No Operation. The default setting is **Switch to PC**. When you press the Physical Button, the device will switch to PC.

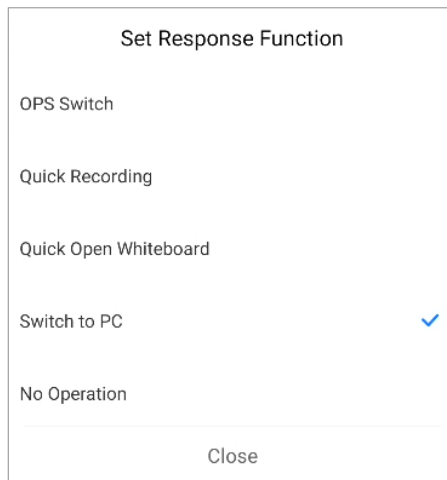

Figure 6-14 Response Function Settings

Step 3 Tap **Long Press Physical Button** to set the function. When you press and hold the Physical Button, the corresponding function that you set will be operated.

6.9 Advanced Settings

Select **Settings** → **Advanced Settings**. You can set parameters as follows.

Advanced Settings		
Email	Settings	>
Input Source Settings	Settings	>
Select Camera	None	>
Input Device	Line In	>
Output Device	System speaker	>
Startup/Shutdown	Settings	>
Device Permission	Settings	>
QR Code Sharing Settings	Share in LAN Only	>
Wakeup Settings	Settings	>

Figure 6-15 Advanced Settings

E-mail

Set the E-mail address for receiving shared contents from whiteboard.

Input Source Settings

- Startup Input Source

Select the desired input source as the device starts up. You can select a built-in system, or an external input source. The default boot input source is Android. Customize input source names are supported.

- Auto Switch When Connecting Signal Source

If this function is enabled, the system will switch to the newly-connected input source when an external input source is connected.

- Auto Switch When Disconnected from Signal Source

If this function is enabled, the system will switch to the configured input source as the device is disconnected from the external input source.

Select Camera

Select a camera among those bound to the device.

Input Device

It supports external USB input audio devices, and can select audio input devices from multiple devices.

Output Device

It supports external USB output audio devices, and can select audio output devices from multiple devices.

Startup/Shutdown Settings

- Startup Mode
Select Startup or Standby.
- Scheduled On/Off
Set the schedule for startup and shutdown.
- No-Signal Shutdown
Set the time for auto-shutdown if no signal is accessible.

Device Permission Settings

- Disable Wi-Fi
If Wi-Fi is disabled, the device cannot be connected to the wireless network.
- Disable USB Flash Drive
If you disable USB flash drive, the external storage device cannot be used.

QR Code Sharing Settings

Share the content of whiteboard through a QR code with other devices in the same LAN.

Wakeup Settings

- Wake from Serial Port
If this function is enabled, the device in standby status can be woken up by serial port command.
- Wake from Signal Source
HDMI signal wake-up is enabled by default. When the device is turned off, it can be turned on through HDMI input.

Note

If this function is disabled, the device in standby status can be waken up through the power switch or remote control power switch, and cannot be turned on through the serial port and HDMI.

EDID Version

Supports to select EDID's version.

Energy Saving Shutdown

Click **Shutdown** to turn off the device and save energy.

6.10 User Settings

Go to **Settings** → **User Settings** to set the account information and login method.

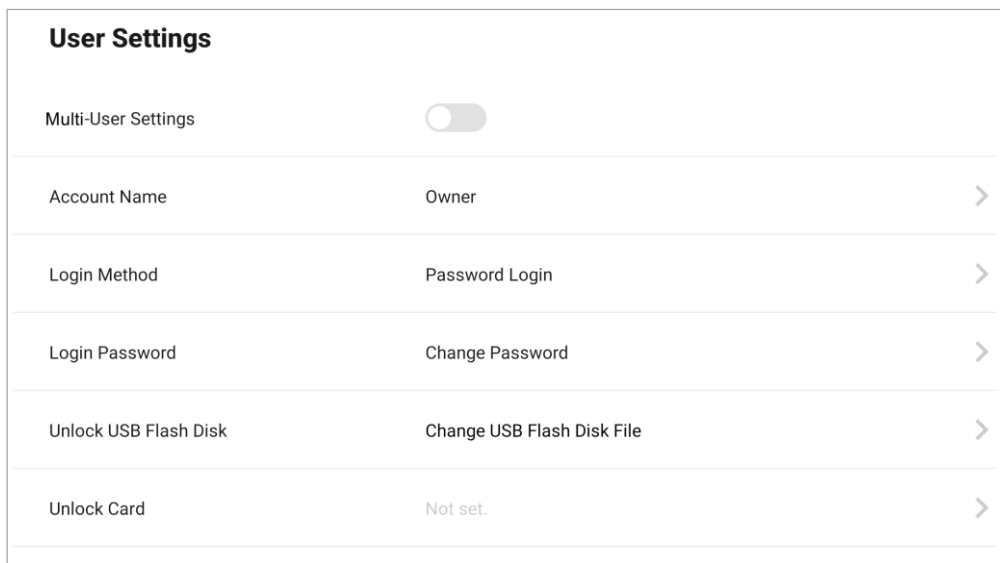

Figure 6-16 User Settings

Multi-User Settings

Enable **Multi-User Settings**, you can edit the current user, set the login methods, add, change and delete accounts.

Account Name

You can set and edit your own account name.

Login Method

Choose the login method from **Password-Free Login** or **Password Login**.

Login Password

Tap to set and change the login password.

Unlock USB Flash Disk

Tap to set the login method with USB Flash Disk.

Steps

Step 1 Click **Unlock USB Flash Disk**.

Step 2 Enter the login password, and then insert one USB flash drive.

Step 3 Click **Generate File**. The device will automatically generate the unlocking file in the USB flash drive. After the file is generated, you can log in easily by directly inserting the USB flash drive next time.



Figure 6-17 Link the Unlocking USB Flash Drive

Unlock Card

Tap to set the login method with the unlocking card.

Steps

Step 1 Click **Unlock Card**.

Step 2 Enter the login password, and you can see **Link the Unlocking Card**.

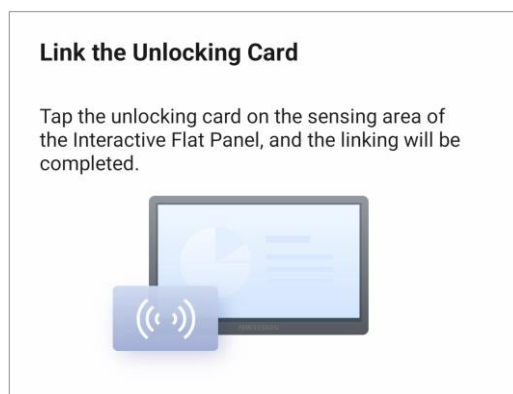

Figure 6-18 Link the Unlocking Card

Step 3 Tap the unlocking card on the sensing NFC area of the device. After the linking is completed, you can directly tap the unlocking card on the sensing area next time to log in.

6.11 Device Information

Go to **Settings** → **About** to check the device information. The device name is customizable, and you can restore the device to the default settings.



All the data will be lost if the settings are restored to the default status.

6.12 Negative Screens

Slide from the left side of the screen to the right to call up the negative screens, where you can view the device status and system help.

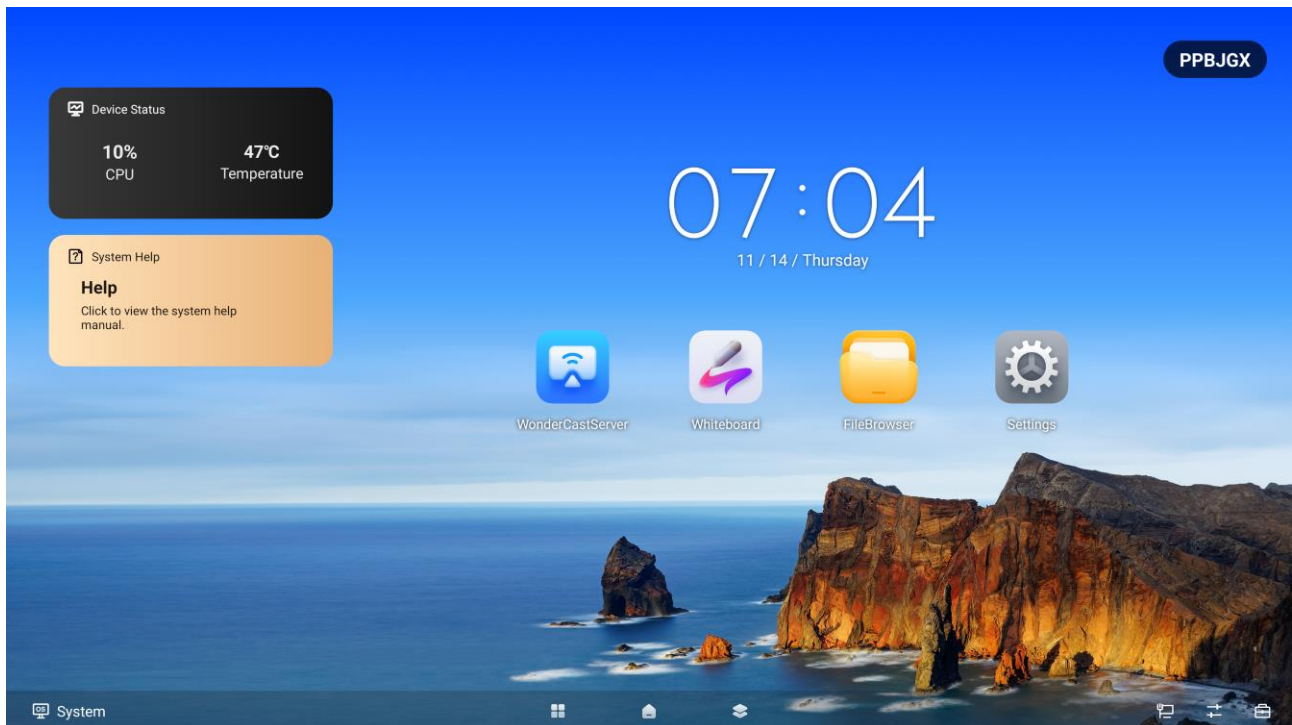

Figure 6-19 Negative Screens

Chapter 7 Intelligent Applications

7.1 FileBrowser

Tap **FileBrowser** on the main page. All the files under the current directory are shown by default. Tap **Image**, **Doc**, **AV**, or **Installation Package** to view specified files.

Icons are described as follows.

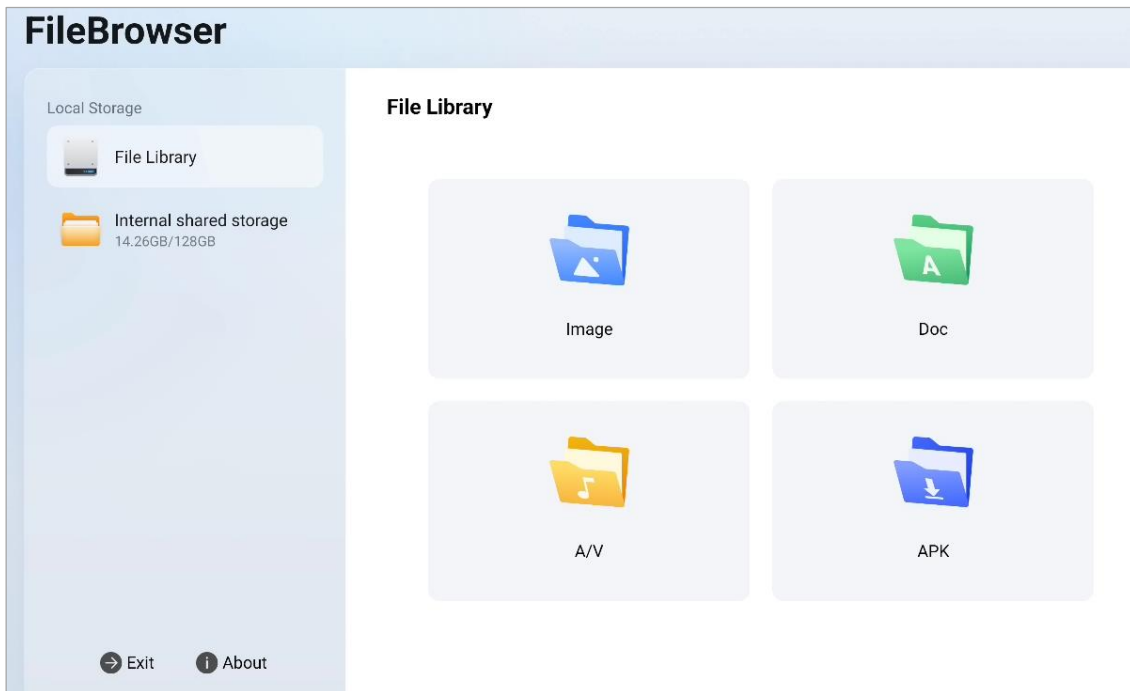



Figure 7-1 File Management

Table 7-1 Descriptions of File Management Icons

Icon	Description	Icon	Description
Back/Forward	Go to the previous/next page.	Create	Create a new folder.
Grid/List	View the files in grid or list mode.	Sort	Change the file order.
Edit	Edit the files.	--	--

Click  to edit documents. More functions are described as follows.

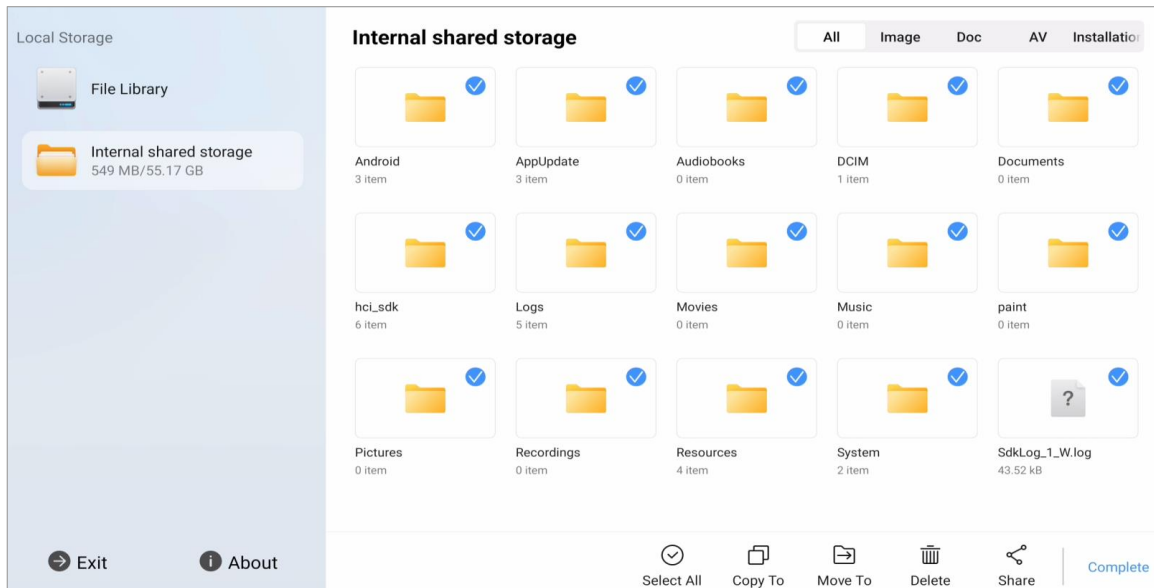

Figure 7-2 Edit the Files

Table 7-2 Descriptions of Editing Icons

Icon	Description	Icon	Description
Select All	Select all the files.	Copy To	Copy the selected file(s) to another folder.
Move To	Move the selected file(s) to another folder.	Delete	Delete the selected file(s).
Share	Share the selected file(s).	/	/

Note

Press and hold the file to perform other operations.

7.2 Browser

Connect the device to the Internet, and tap **Browser**. Enter URL in the address bar to view texts, pictures, audios and videos on the Internet.

7.3 Whiteboard

Whiteboard is an editing software that integrates functions such as touch writing, image insertion, and content sharing. Users can add boards with different backgrounds for touch writing, erasing, and page switching operations. It supports importing and editing images, and after the whiteboard content is completed, it can be saved locally or shared via email.

7.3.1 Toolbar Basic Operations

By using the toolbar, you can write, erase, select, restore/undo, and take other operations on the whiteboard.



Figure 7-3 Toolbar

Write

The writing function is used to write on a whiteboard. Tap  on the toolbar to adjust parameters such as brush type, color, thickness, etc.

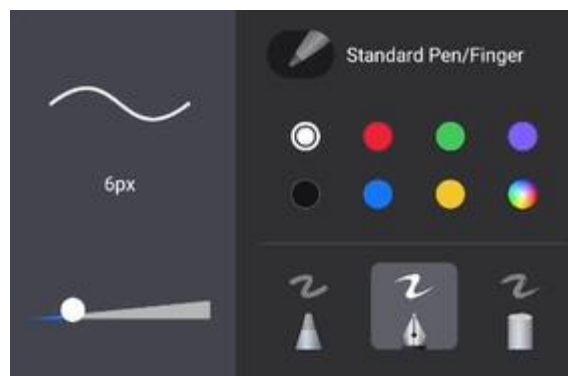







Figure 7-4 Set Writing Parameters



Erase



The erase function is used to erase the content written on the whiteboard. Tap  on the toolbar to select the following actions:

- Partial Erase: Tap , click and drag the eraser on the area that needs to be deleted, and the content of the covered area will be deleted. Supports sliding the slider to adjust the size of the eraser.
- Circle Erase: Tap  to circle the area that needs to be deleted. The content of the trajectory touched in the circle area will be deleted.
- Erase All: Tap  to clear all written content on the current whiteboard page.
- Gesture Erasing: When your palm, or back of hand contact with the screen, you can perform large-scale erasing operations.

Circle Selection

Tap  on the toolbar to circle any shaped area () or rectangular area () and edit the content in the area.

- : Change the color of the content in the selected area uniformly.
- : Delete the content within the selected area.



- : Lock the content within the selected area. Long press on the area or tap  to unlock.
- : Copy the content of the area.

 **Note**

- Support resizing, moving, and rotating the content in the selected area.
- Tap outside the selected area to cancel the area selection.

Undo or Redo

When accidentally writing or erasing, the undo tool can be used to undo your operation.

- : Click to undo the last action;
- : Click to redo the previous action.

7.3.2 More Tools

Tap  on the toolbar to call up the following tools:

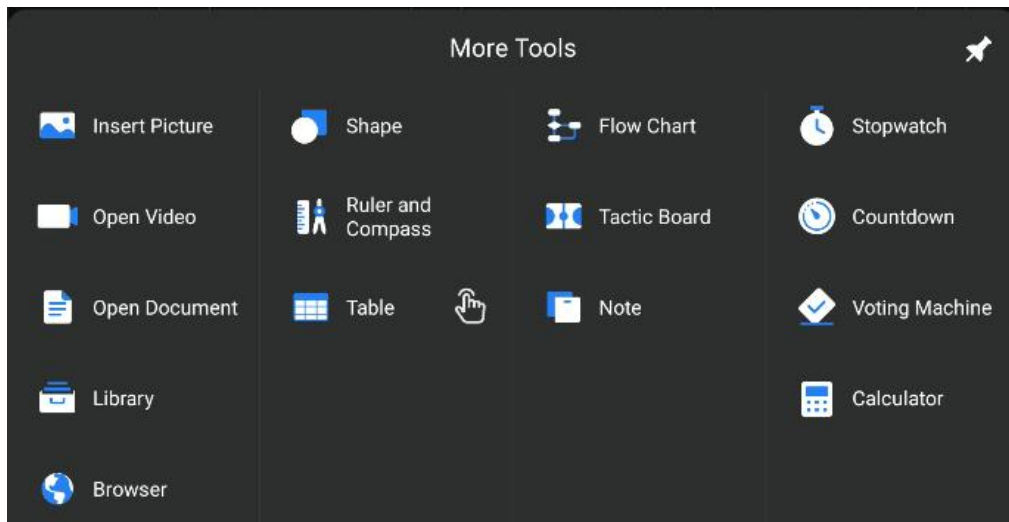



















Figure 7-5 More Tools

Table 7-3 Tools Description

Icon	Name	Description
	Shape	Insert 2D and 3D shapes.
	Ruler and Compass	Use a ruler, protractor, square, or compass. Drag to adjust size and angle.
	Table	<ul style="list-style-type: none"> • Insert a table. • Long press the table to add/delete rows or columns; • Drag the table to move or resize it; • Tap the table to choose to modify the color of the content written in the table. • Click  and enable Shape Recognition. You can draw horizontal and vertical lines to trigger table recognition.
	Flow Chart	<ul style="list-style-type: none"> • You can select different shapes and lines to draw a flowchart on the whiteboard. • Click  to fix the shape bar.
	Tactic Board	Tap to create a basketball tactic board.
	Note	Insert a note. Support moving, resizing, copying notes, and changing the color of notes.
	Stopwatch	Open the stopwatch.
	Countdown	Open the countdown.
	Voting Machine	Open the voter machine.
	Calculator	Open the calculator.
	Insert Picture	After inserting a picture, you can lock, resize, move, rotate, delete the picture, and modify the color of the content written in the area.
	Open Video	Play video files.
	Open Document	Open documents in PPT, PPTX, DOC, DOCX, and PDF for display.
	Library	Tap to search images and videos and insert.
	Browser	Call up the browser on the side of the whiteboard.

 **Note**

- You can click  to bring up the sidebar.

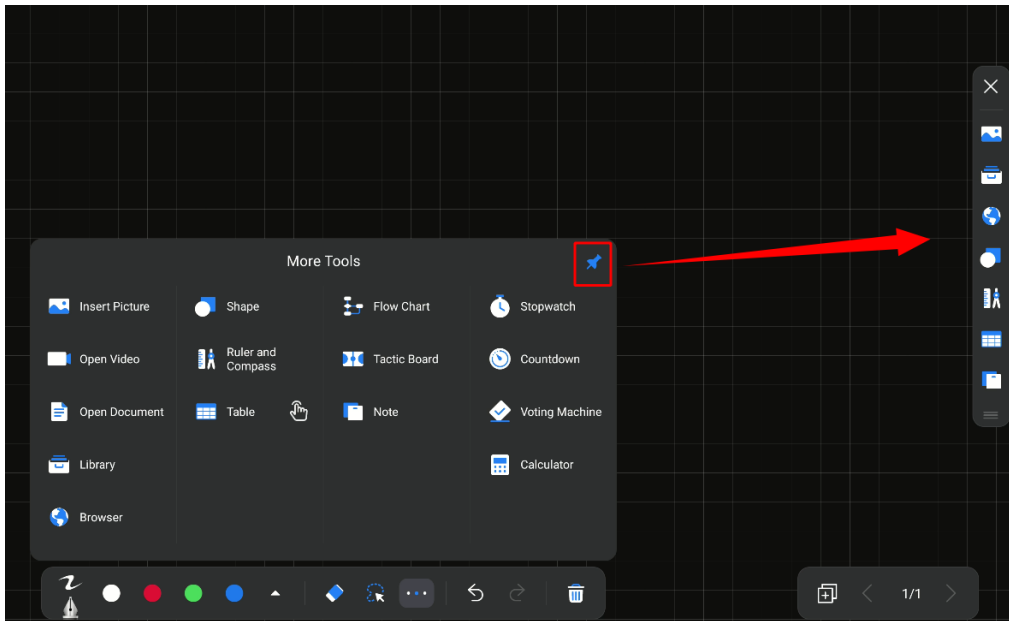

Figure 7-6 Tools Sidebar

- You can draw a line on any corner of the shape or table to expand.

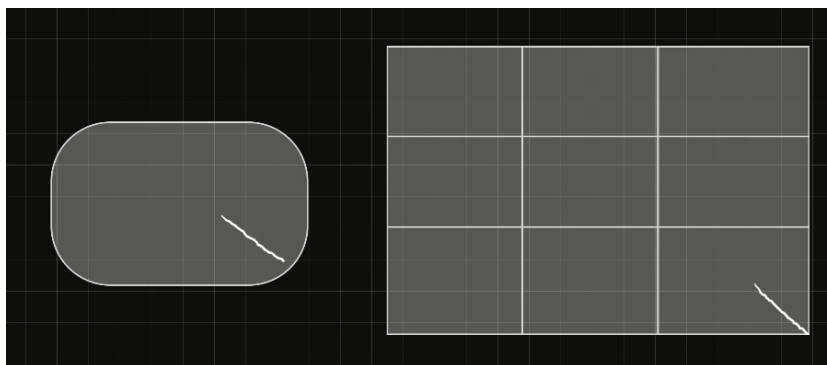





Figure 7-7 Expand Shape and Table

- **Library** and **Browser** are only supported when the Whiteboard application is full screen.
- Functions may vary in different scenarios. Please refer to the actual page.

Tactic Board

- 1) Tap  to create a tactic board. Move  to change the player's position.
- 2) Enable  on the lower-right corner to draw a line on a player. Line types will be prompted and you can select one.

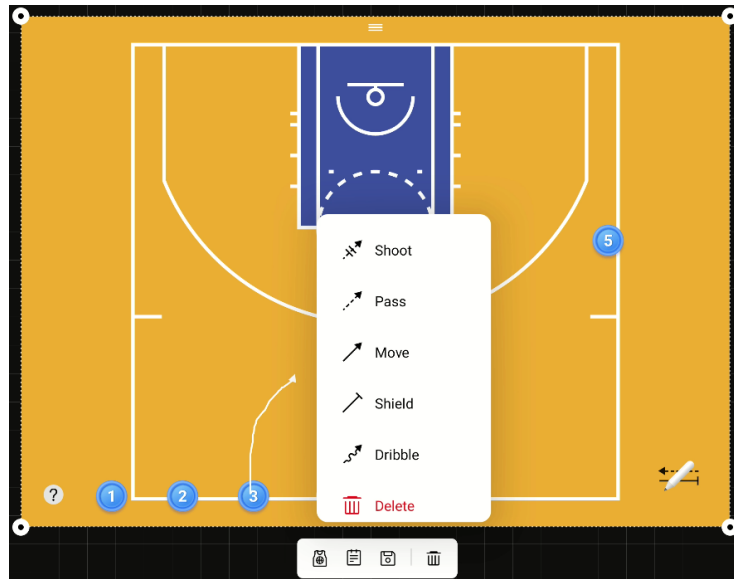



Figure 7-8 Select Line Type

- 3) Click  to select the number of players. Click  to select a tactic.

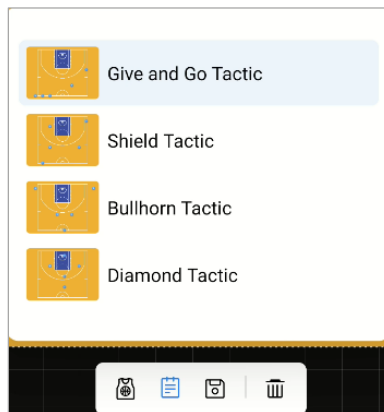





Figure 7-9 Select Tactic

- 4) Draw your own tactic on the board, and click  to name the tactic and save. You can find your own saved tactic in .
- 5) Click  on the lower-left corner to see the function guide.

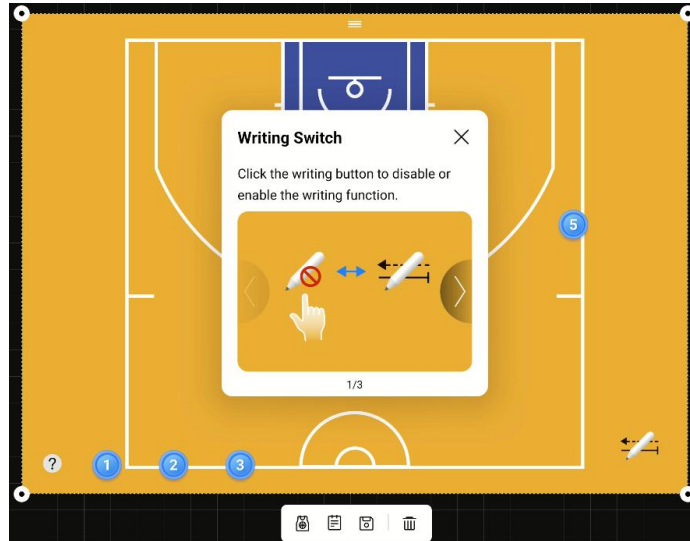

Figure 7-10 Function Guide

Open Document

You can insert a whiteboard document in PDF format and edit on it.

Steps

Step 1 Save the current whiteboard page in PDF format, and the file will be saved in FileBrowser automatically.

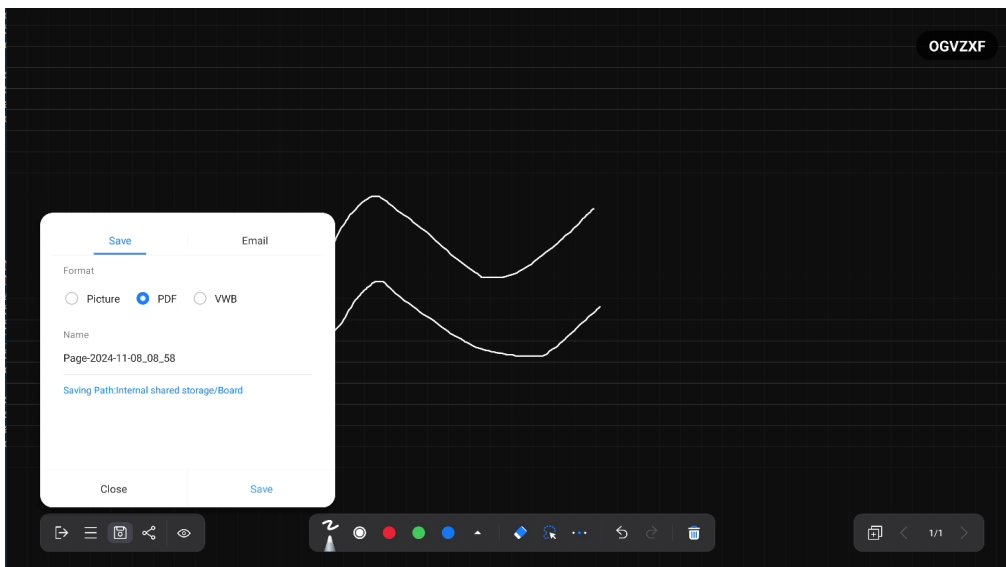

Figure 7-11 Save in PDF Format

Step 2 Tap  →  **Open Document**, and select **FileBrowser**. Tap **Board**, and you will find the saved whiteboard document.

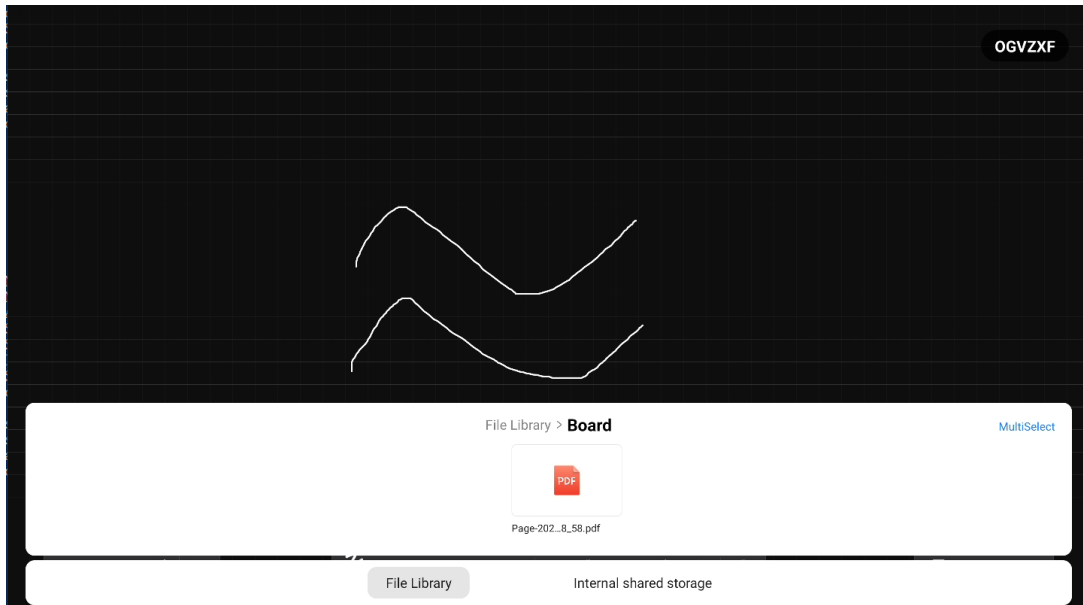

Figure 7-12 Open Document

Step 3 Click the document to insert, and you can edit on the saved whiteboard page.

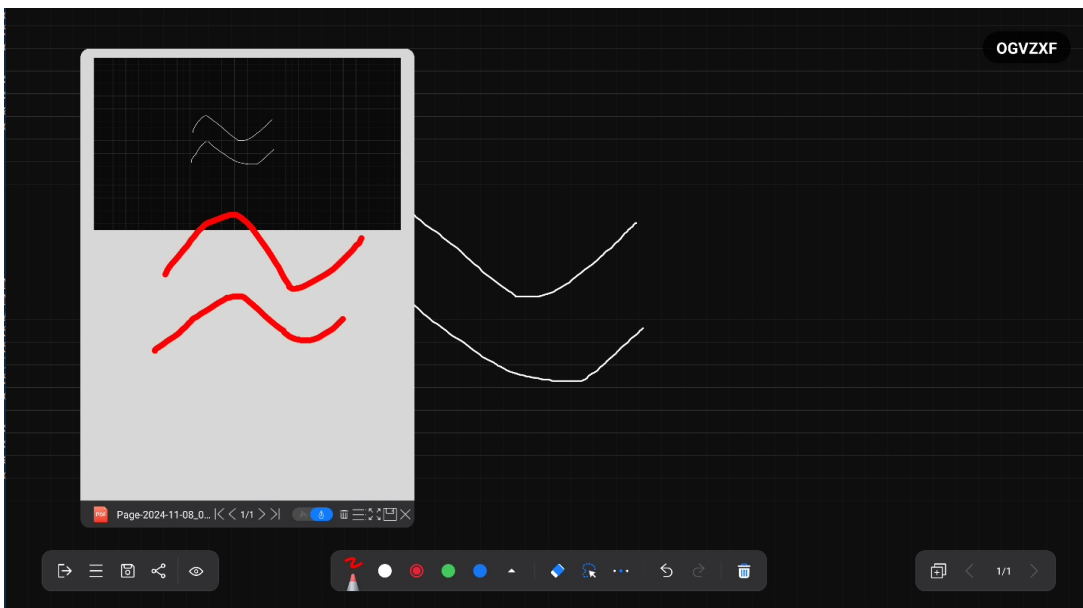
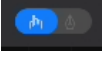







Figure 7-13 Edit on Document





Table 7-4 Functions on Inserted Document

Icon	Description
	Slide or write on the document.
	Delete edition on the document.
	Find the thumbnail on the right side. You can choose to see the thumbnail or the page number.
	Expand the inserted document.
	Save the edited document.
	Close the inserted document.

7.3.3 Manage Whiteboard

You can create a new whiteboard, switch whiteboards, and delete whiteboards.

Table 7-5 Function Description

Function	Description
Add Whiteboard	Tap  on the bottom right corner to add a whiteboard page.
Switch Whiteboard	Tap  to switch the whiteboard page.
Drag Whiteboard	A single whiteboard is infinitely large, and you can drag the whiteboard page up, down, left, right with five fingers to extend writing space.
View Whiteboard	Tap  on the page number area to display a thumbnail of the whiteboard page. Swipe the thumbnail up and down, and tap a page to jump to the displayed page.
Delete Whiteboard	Tap  on the page number area and tap  on the bottom right corner of the page to delete that page.

Note

All information will be reset after closing the whiteboard.

7.3.4 Save Whiteboard

After the whiteboard content is completed, the page can be saved locally on the device for reference or shared with others.

Steps

Step 1 Tap  on the bottom left of the whiteboard.

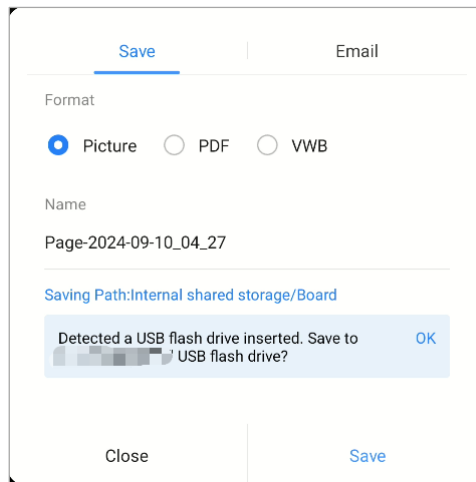

Figure 7-14 Save Whiteboard

Step 2 Select a format.

Note

Support saving the board as PNG format images, PDF format documents, or editable VWB format files.

Step 3 (Optional) Edit the name of the board.

Step 4 Tap **Save**.

7.3.5 Share Whiteboard

Users can share whiteboards with others via email or QR code.

Share via Email

Tap  on the bottom left of the whiteboard and select **Email**.

Note

Make sure the Email server has been configured before you start.

Share Via QR Code

Tap  on the bottom left corner, mobile devices on the same LAN can scan the code to download whiteboard content.

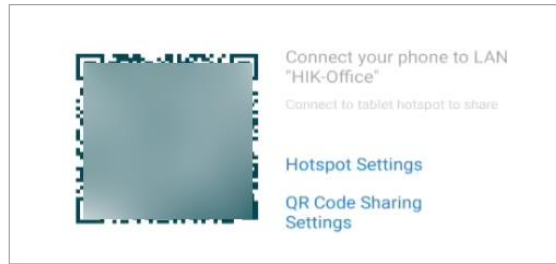



Figure 7-15 Share via QR Code

7.3.6 More Functions

Tap  on the bottom left corner of the whiteboard to achieve functions such as split-screen writing and dual-color writing.

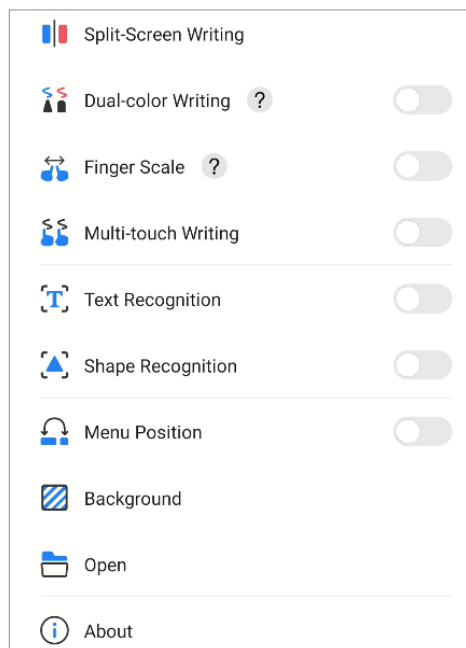





Figure 7-16 More Functions

Split-Screen Writing

Support whiteboard simultaneous writing on split screens.

- Tap  or  switch between two or three screens.
- Tap  to exit split-screen writing mode.

Note

When changing the number of split screens and exiting split-screen writing, the current content will not be saved.

Dual-Color Writing

After enabling, different colors can be selected for writing on the tip and tail of the writing pen.

 **Note**

- Long press the stroke support for adjusting the pen's threshold.
- You can click  to see the function guide.

Finger Scale

After enabling, you can use 2 fingers to zoom in/out the page. Click  to see the function guide.

Multi-Touch Writing

After enabling, the whiteboard supports multi finger touch, meaning that multiple fingers can simultaneously edit the whiteboard.

Text Recognition

After enabling, the whiteboard can recognize the drawn text and correct it to the regular text.

 **Note**

Multi-Touch Writing and Text Recognition cannot be enabled at the same time.

Shape Recognition

After enabling, the whiteboard can recognize the drawn graphics and correct them to the regular graphics.

 **Note**

- The recognizable shapes include circles, triangles, rectangles, and lines.
- Text recognition and shape recognition do not support simultaneous activation.

Menu Position

After enabling, the menu on the left and page numbers on the right of the whiteboard are swapped for easy access to the function icons and menus.

Background

Set the background and shading of the whiteboard, and you can customize the whiteboard background style as needed.



Open

Open the whiteboard file saved as a VWB format for editing again.

About

View the current version and open source agreement.

Hide Toolbar

Tap  on the bottom left corner to hide the toolbar. Tap  to expand.

7.4 WonderCastServer

You can mirror the screen of your PC or mobile phone on the Interactive Flat Panel, or control the Flat Panel through your PC or phone. Please scan the following QR code for more details about WonderCastServer.



Figure 7-17 WonderCastServer

7.5 System Pre-installed Applications

The following table briefly describes the applications pre-installed in the system. Refer to the help document of desired application, to get more details.



Note

The system pre-installed applications vary from different device types.

Table 7-6 Introduction of System Pre-installed Applications

Application	Introduction
Whiteboard	It is applied to draw and write. You can use it to save, move, zoom in, zoom out, delete, and download the contents.
FileBrowser	Manage your files.
Browser	After the device is connected to the network, it can browse internet information through a browser.
Gallery	It is used for viewing pictures in SD card and USB disk.
Upgrade	It provides remote upgrade and local upgrade, and upgrade of local components.
WonderCastServer	An application used to connect flat panel, mobile phone, or PC for screen mirroring.
Camera	It is used for taking picture by camera.

Chapter 8 Appendix A FAQs

Question	Cause and Solution
Why do the condensations appear frequently on the screen?	Tempered glass is installed on the outer screen to provide protection. There is a gap between the screen and the tempered glass for air convection. The main reason is that there is a temperature difference between the screen and the outside. Hot air condenses on the glass surface at a lower temperature, which results in condensations. Condensations will evaporate after the device starts up and will not affect the use of the device.
Why there is no sound coming from my laptop after connection?	If only audio cable is accessed, both audio output and image output will be unavailable. <ul style="list-style-type: none"> ● Access HDMI cable. ● Select the device as the audio output device in Windows.
Why does the screen get hot after a period of use?	Screen temperature rise is caused by heat dissipation and is completely normal. Our heat dissipation design is industrial-leading and is the formulator of the industry standards, which is in accordance with the national health standard.
Does long-time use damage the eyes?	The recognition of flicker by human eyes is 50Hz. If the frequency is lower than 50Hz, then the flicker will be recognized and cause eye muscles fatigue. We use 60Hz LCD screen, human eyes will not recognize the flicker of the screen. Compared with other products of the same kind, it can reduce eye fatigue to a large extent.
Why there is no image in screen nor sound coming from the device?	<ul style="list-style-type: none"> ● Check if the power cable is connected. ● Check if the socket works normally. ● Check if the power switch is turned on.
Why does the device HDMI channel have no input signal?	<ul style="list-style-type: none"> ● Check if the input source works normally. ● Change HDMI interface or cable. ● If PC is accessed, set HDMI output on your PC.
Why is wired network unstable?	Try to disable the auto network detection option.



See Far, Go Further