

DS-K1T343 Series Face Recognition Terminal

Quick Start Guide

UD24344B-E

1 Installation

Installation Environment

- Indoor use only.
- Avoid backlight, direct sunlight, and indirect sunlight.
- For Better recognition, there should be light source in or near the installation environment.
- The minimum bearing weight of the wall or other places should be 3 times heavier than the device weight.

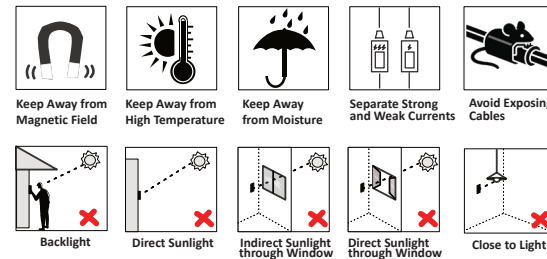

Wall Mounting

- Make sure the gang box is installed on the wall.

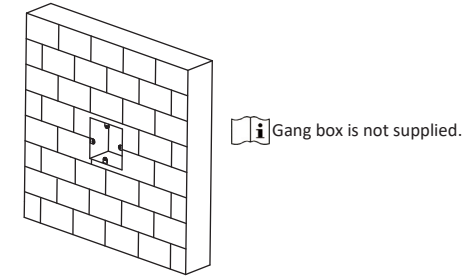

- Secure the mounting plate on the gang box with the supplied screws (M4). Route the cable through the cable hole, wire the cables and insert the cables in the gang box.

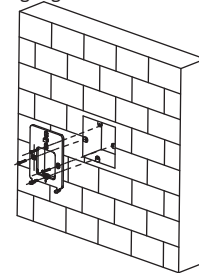

- Align the device with the mounting plate, and secure the device on the mounting plate with 1 supplied screw (M3).

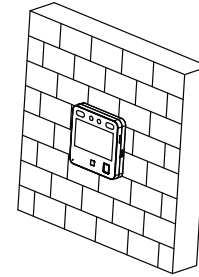

- You can install the battery backplane (supplied) with 3 screws (SC-KA4X22) before installing the device. The dimension with the battery backplane is as below. (unit: mm [inch])

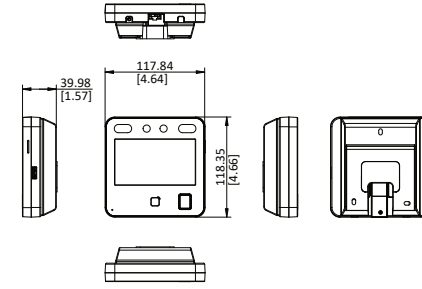

Base Mounting

- Route the cable through the cable hole of the bracket. Align the bracket with the device rear panel.

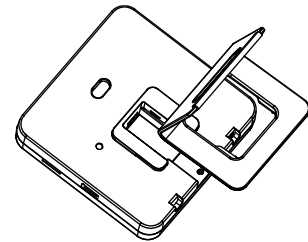

- Press the bracket with both hands. Make sure the rear panel of the device and the buckles of the bracket are aligned with each other. Slide and buckle the bracket along the arrow.

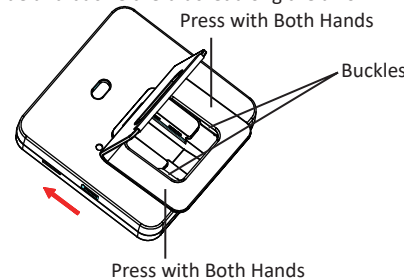

- Slide to the end to complete the installation.

- You can install the battery backplane (supplied) with 3 screws (SC-KA4X22) before installing the device. The dimension with the battery backplane is as below. (unit: mm [inch])

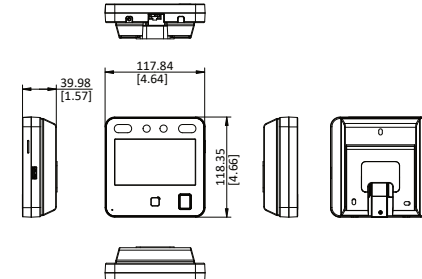

2 Appearance

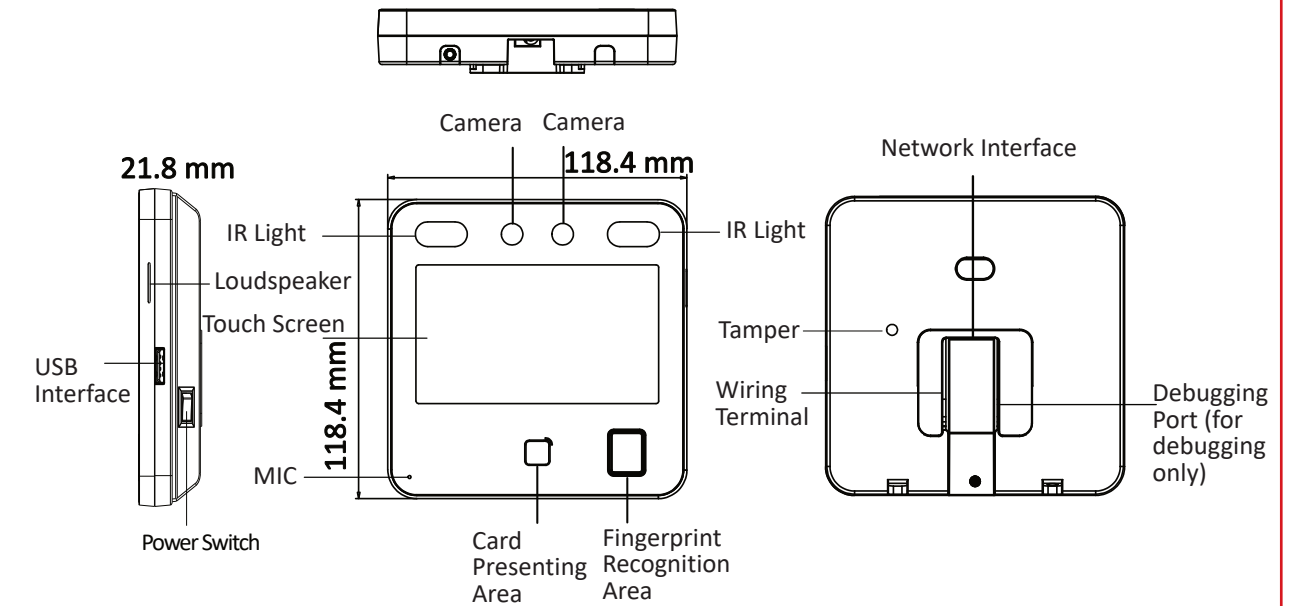

Power Switch Description

- If the power switch is on, 12 V power supply is connected, then the backup battery is in charging status.
- If the power switch is on, 12 V power supply is disconnected, then the backup battery is discharged.
- If the power switch is off, 12 V power is off, then the backup battery is not working.

3 Wiring

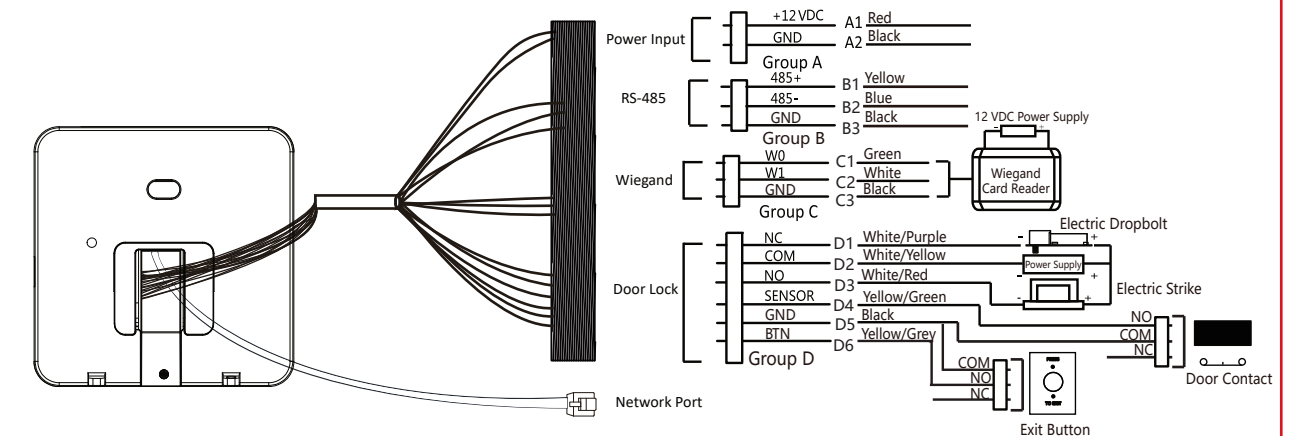

- If connects to an access controller, you should set the Wiegand direction as Output to transmit authentication information to the access controller.
- For details about Wiegand direction settings, see *Set Wiegand Parameters*.
- Do not wire the device to the electric supply directly.

Cable Requirements

Cable Size	18 AWG	15 AWG	12 AWG
Power Supply	12 V Switched-mode	12 V Switched-mode	12 V Switched-mode
Distance Between Power Supply and Device	≤ 20 m	≤ 30 m	≤ 40 m

About this Document
 This Document includes instructions for using and managing the Product. Pictures, charts, images and all other information herein are for descriptive and explanatory purposes only.
 The information contained in this Document is subject to change, without notice, due to firmware updates or other reasons. Please find the latest version of the Document at the Hikvision website (<http://www.hikvision.com>). Unless otherwise agreed, Hangzhou Hikvision Digital Technology Co., Ltd. or its affiliates (hereinafter referred to as "Hikvision") makes no warranties, express or implied.
 Please use this Document with the guidance and assistance of professionals trained in supporting the Product.

About this Product
 This product can only be used in the country or region where the purchase is made.
Acknowledgment of Intellectual Property Rights
 Hikvision owns the copyrights and/or patents related to the technology embodied in the Products described in this Document, which may include licenses obtained from third parties.
 Any part of the Document, including text, pictures, graphics, etc., belongs to Hikvision. No part of this Document may be copied, translated, or modified in whole or in part by any means without written permission.
 HIKVISION and other Hikvision's trademarks and logos are the properties of Hikvision in various jurisdictions.
 Other trademarks and logos mentioned are the properties of their respective owners.

LEGAL DISCLAIMER
 TO THE MAXIMUM EXTENT PERMITTED BY APPLICABLE LAW, THIS DOCUMENT AND THE PRODUCT DESCRIBED, WITH ITS HARDWARE, SOFTWARE AND FIRMWARE, ARE PROVIDED "AS IS" AND "WITH ALL FAULTS AND ERRORS". HIKVISION MAKES NO WARRANTIES, EXPRESS OR IMPLIED, INCLUDING WITHOUT LIMITATION, MERCHANTABILITY, SATISFACTORY QUALITY, OR FITNESS FOR A PARTICULAR PURPOSE. THE USE OF THE PRODUCT BY YOU IS AT YOUR OWN RISK. IN NO EVENT WILL HIKVISION BE LIABLE TO YOU FOR ANY SPECIAL, CONSEQUENTIAL, INCIDENTAL, OR INDIRECT DAMAGES, INCLUDING, AMONG OTHERS, DAMAGES FOR LOSS OF BUSINESS PROFITS, BUSINESS INTERRUPTION, OR LOSS OF DATA, CORRUPTION OF SYSTEMS, OR LOSS OF DOCUMENTATION, WHETHER BASED ON BREACH OF CONTRACT, TORT (INCLUDING NEGLIGENCE), PRODUCT LIABILITY, OR OTHERWISE, IN CONNECTION WITH THE USE OF THE PRODUCT, EVEN IF HIKVISION HAS BEEN ADVISED OF THE POSSIBILITY OF SUCH DAMAGES OR LOSS.

YOU ACKNOWLEDGE THAT THE NATURE OF THE INTERNET PROVIDES FOR INHERENT SECURITY RISKS, AND HIKVISION SHALL NOT TAKE ANY RESPONSIBILITIES FOR ABNORMAL OPERATION, PRIVACY LEAKAGE OR OTHER DAMAGES RESULTING FROM CYBER-ATTACK, HACKER ATTACK, VIRUS INFECTION, OR OTHER INTERNET SECURITY RISKS; HOWEVER, HIKVISION WILL PROVIDE TIMELY TECHNICAL SUPPORT IF REQUIRED.
 YOU AGREE TO USE THIS PRODUCT IN COMPLIANCE WITH ALL APPLICABLE LAWS, AND YOU ARE SOLELY RESPONSIBLE FOR ENSURING THAT YOUR USE CONFORMS TO THE APPLICABLE LAW. ESPECIALLY, YOU ARE RESPONSIBLE, FOR USING THIS PRODUCT IN A MANNER THAT DOES NOT INFRINGE ON THE RIGHTS OF THIRD PARTIES, INCLUDING WITHOUT LIMITATION, RIGHTS OF PUBLICITY, INTELLECTUAL PROPERTY RIGHTS, OR DATA PROTECTION AND OTHER PRIVACY RIGHTS. YOU SHALL NOT USE THIS PRODUCT FOR ANY PROHIBITED END-USES, INCLUDING THE DEVELOPMENT OR PRODUCTION OF WEAPONS OF MASS DESTRUCTION, THE DEVELOPMENT OR PRODUCTION OF CHEMICAL OR BIOLOGICAL WEAPONS, ANY ACTIVITIES IN THE CONTEXT RELATED TO ANY NUCLEAR EXPLOSIVE OR UNSAFE NUCLEAR FUEL-CYCLE, OR IN SUPPORT OF HUMAN RIGHTS ABUSES.

Data Protection
 To protect data, the development of Hikvision Products incorporates privacy by design principles. For example, for Products with facial recognition features, biometrics data is stored in your Products with encryption method; for fingerprint Products, only fingerprint template will be saved, which is impossible to reconstruct a fingerprint image.
 As a data controller/processor, you may process personal data, including collection, storage, use, processing, disclosure, deletion, etc. You are advised to pay attention to and comply with applicable laws and regulations related to the protection of personal data, including without limitation, conducting security controls to safeguard personal data, such as, implementing reasonable administrative and physical security controls, conducting periodic reviews and the assessments of the effectiveness of your security controls.

© Hangzhou Hikvision Digital Technology Co., Ltd. All rights reserved.
 Scan the QR code to get the user manual for detailed information.



Use only power supplies listed in the user instructions:

Model	Manufacturer	Standard
ADS-26FSG-12 12024EPG	Shenzhen Honor Electronic Co.,Ltd	PG
MSA-C2000IC12.0-24P-DE	MOSO Technology Co.,Ltd	PDE
ADS-24S-12 1224GPG	Shenzhen Honor Electronic Co., Ltd.	PB

4 Quick Operation

● Activation via Device

After powering on, you will enter the activation page.

Steps:

1. Create a password and confirm the password.
2. Tap **Activate** to activate the device.

Characters containing admin and nmda are not supported to be set as activation password.



We highly recommend you to create a strong password of your own choosing (using a minimum of 8 characters, including at least three kinds of following categories: upper case letters, lower case letters, numbers, and special characters) in order to increase the security of your product. And we recommend you change your password regularly, especially in the high security system, changing the password monthly or weekly can better protect your product.

● Set Language

Select a language from the drop-down list.

● Set Application Mode

After activation, you should select an application mode. Select **Indoor** or **Others** from the drop-down list and tap **OK**.

If you install the device indoors near the window or the face recognition function is not working well, select **Others**.

● Set Network Parameters

Wired Network:

-If enable **DHCP**, the system will assign the IP address and other parameters automatically.

-If disable **DHCP**, you should manually set the IP address and other parameters.

Wi-Fi:

-Select a Wi-Fi and enter the Wi-Fi's password.

-Or tap **Add Wi-Fi** and enter the Wi-Fi's name and password.

If you select **Wired Network**, make sure the device has connected to a network.

● Access to Guarding Vision

You can add the device to the Hik-Connect mobile client. Enable **Access to Guarding Vision**, and set the Server IP and Verification Code.

● Privacy Settings

Set the privacy parameters, including the picture uploading and storage.

● Set Administrator

Steps:

1. (Optional) Edit the employee ID.
2. Enter the administrator's name and tap **OK**.
3. Select a credential to add. You can select face and fingerprint.
 - Add Face: Tap to capture. And tap to save.
 - Add Fingerprint: Tap the fingerprint icon, and add fingerprint according to the prompt.
 - Add Card: Swipe the card in the swiping area according to the prompt or enter the card number.
4. Tap **OK**.

Only the device with the fingerprint module supports the fingerprint functions.

5 Add Face Picture

1. Use finger to hold the screen surface for 3 s and slide to right/left and enter the activation password to enter the Home page.

2. Enter the User Management page, tap + to enter the Add User page.

3. Set the user parameters according to actual needs

Only the device with the fingerprint module support the fingerprint related functions.

4. Tap **Face** and add the face information according to the instructions. You can view the captured picture on the screen, Make sure the face picture is in good quality and size. For details about the tips and positions when collecting or comparing the face picture, see the contents on the right.

5. If the picture is in good condition, tap . Or tap to take another face picture.

6. Tap the save icon to save the settings. Go back to the initial page to start authentication. For other authentication methods, see the device user manual.

User other authentication methods if the device is affected by the light or other items.



Biometric recognition products are not 100% applicable to anti-spoofing environments. If you require a higher security level, use multiple authentication modes.

Tips When Collecting/Comparing Face Picture

Expression

- Keep your expression naturally when collecting or comparing face pictures, just like the expression in the picture on the right.
- Do not wear hat, sunglasses, or other accessories that can affect the facial recognition function.
- Do not make your hair cover your eyes, ears, etc. and heavy makeup is not allowed.



Posture

In order to get a good quality and accurate face picture, position your face looking at the camera when collecting or comparing face picture.

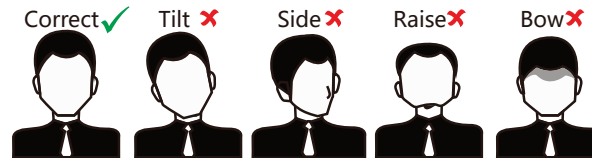

Size

Make sure your face is in the middle of the collecting window.

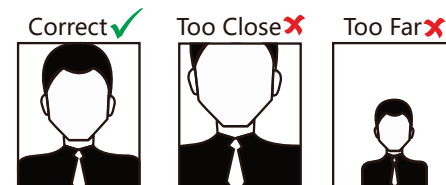

Positions When Collecting/Comparing Face Picture

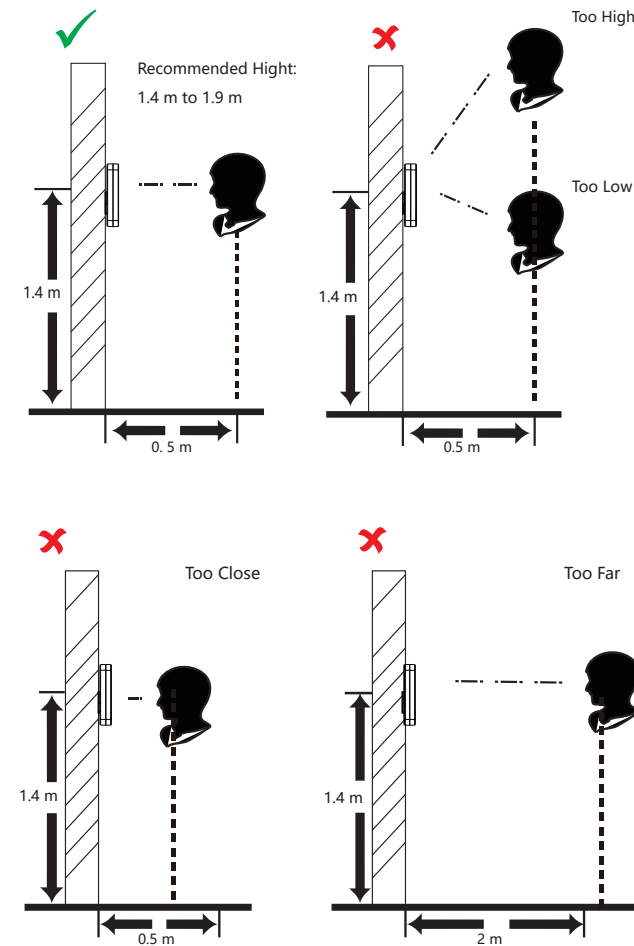

Safety Instruction



- Warning**
- In the use of the product, you must be in strict compliance with the electrical safety regulations of the nation and region.
 - Do not connect several devices to one power adapter as adapter overload may cause over-heat or fire hazard.
 - If smoke, odors or noise rise from the device, turn off the power at once and unplug the power cable, and then please contact the service center.
 - The socket-outlet shall be installed near the equipment and shall be easily accessible.
 - 1. Do not ingest battery. Chemical burn hazard!
 - 2. This product contains a coin/button cell battery. If the coin/button cell battery is swallowed, it can cause severe internal burns in just 2 hours and can lead to death.
 - 3. Keep new and used batteries away from children.
 - 4. If the battery compartment does not close securely, stop using the product and keep it away from children.
 - 5. If you think batteries might have been swallowed or placed inside any part of the body, seek immediate medical attention.
 - 6. CAUTION: Risk of explosion if the battery is replaced by an incorrect type.
 - 7. Improper replacement of the battery with an incorrect type may defeat a safeguard (for example, in the case of some lithium battery types).
 - 8. Do not dispose of the battery into fire or a hot oven, or mechanically crush or cut the battery, which may result in an explosion.
 - 9. Do not leave the battery in an extremely high temperature surrounding environment, which may result in an explosion or the leakage of flammable liquid or gas.
 - 10. Do not subject the battery to extremely low air pressure, which may result in an explosion or the leakage of flammable liquid or gas.
 - 11. Dispose of used batteries according to the instructions.



- Caution**
- Do not drop the device or subject it to physical shock, and do not expose it to high electromagnetic radiation. Avoid the equipment installation on vibrations surface or places subject to shock (ignorance can cause equipment damage).
 - Do not place the device in extremely hot (refer to the specification of the device for the detailed operating temperature), cold, dusty or damp locations, and do not expose it to high electromagnetic radiation.
 - Exposing the equipment to direct sun light, low ventilation or heat source such as heater or radiator is forbidden (ignorance can cause fire danger). The device cover for indoor use shall be kept from rain and moisture.
 - Exposing the equipment to direct sun light, low ventilation or heat source such as heater or radiator is forbidden (ignorance can cause fire danger).
 - Please use a soft and dry cloth when clean inside and outside surfaces of the device cover, do not use alkaline detergents.
 - Biometric recognition products are not 100% applicable to anti-spoofing environments. If you require a higher security level, use multiple authentication modes.
 - The serial port of the equipment is used for debugging only.
 - Wall Mounting: Install the equipment according to the instructions in this manual. To prevent injury, this equipment must be securely attached to the floor/wall in accordance with the installation instructions.
 - Improper use or replacement of the battery may result in hazard of explosion. Replace with the same or equivalent type only. Dispose of used batteries according to the instructions provided by the battery manufacturer.
 - This bracket is intended for use only with equipped devices. Use with other equipment may result in instability causing injury.
 - This equipment is for use only with equipped bracket. Use with other (carts, stands, or carriers) may result in instability causing injury.